

FSA 30.0

STIHL



2 - 25 Instruction Manual



Contents

1	Introduction.....	2
2	Guide to Using this Manual.....	2
3	Overview.....	3
4	Safety Precautions.....	4
5	Preparing Trimmer for Operation.....	11
6	Charging the Battery, LEDs.....	11
7	Assembling the Trimmer.....	12
8	Adjusting Trimmer for User.....	14
9	Removing and Fitting the Battery.....	15
10	Switching the Trimmer On/Off.....	15
11	Testing the Trimmer and Battery.....	16
12	Operating the Trimmer.....	16
13	After Finishing Work.....	17
14	Transporting.....	17
15	Storing.....	17
16	Cleaning.....	18
17	Maintenance.....	19
18	Repairing.....	19
19	Troubleshooting.....	19
20	Specifications.....	20
21	Combinations of Cutting Attachments and Deflectors.....	21
22	Spare Parts and Accessories.....	21
23	Disposal.....	22
24	EC Declaration of Conformity.....	22
25	UKCA Declaration of Conformity.....	22
26	General Power Tool Safety Warnings.....	23

1 Introduction

Dear Customer,

Thank you for choosing STIHL. We develop and manufacture our quality products to meet our customers' requirements. The products are designed for reliability even under extreme conditions.

STIHL also stands for premium service quality. Our dealers guarantee competent advice and instruction as well as comprehensive service support.

STIHL expressly commit themselves to a sustainable and responsible handling of natural resources. This user manual is intended to help you use your STIHL product safely and in an environmentally friendly manner over a long service life.

We thank you for your confidence in us and hope you will enjoy working with your STIHL product.



Dr. Nikolas Stihl

IMPORTANT! READ BEFORE USING AND KEEP IN A SAFE PLACE FOR REFERENCE.

2 Guide to Using this Manual

2.1 Applicable documents

The local safety regulations apply.

- ▶ In addition to this user manual, you should also read, understand and retain the following documents:
 - User manual and packaging of the cutting attachment being used
 - Safety information for STIHL batteries and products with built-in battery: www.stihl.com/safety-data-sheets

2.2 Symbols used with warnings in the text



- This symbol indicates dangers that can cause serious injuries or death.
 - ▶ The measures indicated can avoid serious injuries or death.



- This symbol indicates dangers that can cause damage to property.
 - ▶ The measures indicated can avoid damage to property.

2.3 Symbols in Text



This symbol refers to a chapter in this instruction manual.

3 Overview

3.1 Brushcutter, battery and charger

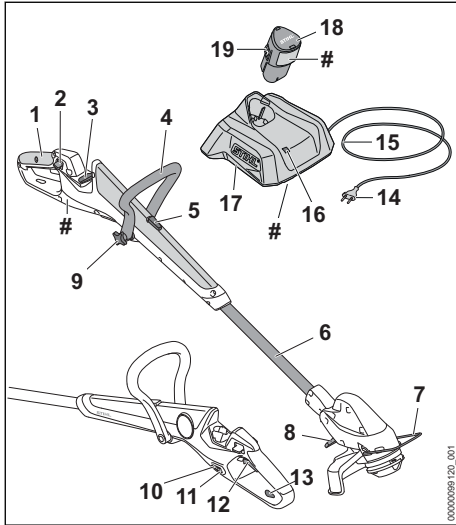

- 1 Control handle**
The control handle is used for operating, holding and guiding the brushcutter.
- 2 Locking levers**
Unlocks the trigger.
- 3 Battery compartment**
Holds the battery.
- 4 Loop handle**
For holding and controlling the brushcutter.
- 5 Locking button**
Locks the shaft at the required length.
- 6 Shaft**
The shaft connects all components.
- 7 Bump guard**
Protects the objects from contact with the cutting attachment.
- 8 Levers**
Locks the selected angle between the shaft and the motor housing.
- 9 Star knob nut**
Secures the loop handle to the shaft.
- 10 LEDs**
The LEDs indicate the state of charge of the battery and any faults.
- 11 Pushbutton**
Activates the LEDs on the brushcutter.

12 Trigger

Switches the brushcutter on and off.

13 Ring

Serves to hang up the brushcutter.

14 Mains plug

The mains plug connects the connecting cable with a socket

15 Connecting cable

The connecting cable connects the charger to the mains plug.

16 LED

The LED indicates the status of the charger.

17 Charger

The charger charges the battery.

18 Battery

The battery supplies power to the brushcutter.

19 Locking hook

Holds the battery in the battery compartment.

Rating plate with machine number

3.2 Deflector and cutting attachments

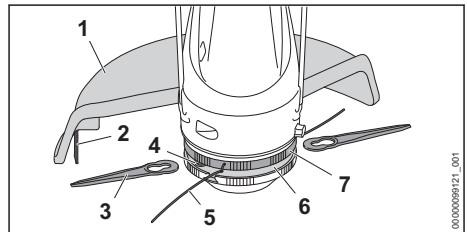

1 Deflector

Protects the user from flying debris and contact with the cutting attachment.

2 Line-limiting blade

The line-limiting blade trims the surplus mowing line to correct length while working.

3 Blade

The blades cut the grass.

4 Mounting

The mounting secures the blades in position.

5 Mowing line

The mowing lines cut grass.

6 Mowing head











Houses the mowing lines and cutting blades.

7 Fanwheel

Cools the electric motor.

3.3 Symbols

Meanings of symbols that may be on the brush-cutter, cutting attachment, battery and the charger:

-  This symbol indicates that the length of the shaft is adjustable.
-  This symbol indicates that the control handle can be rotated 90°.
-  This symbol shows how far the mowing line has to be inserted.
-  This symbol shows in which direction the mowing line has to be inserted.
-  This symbol shows the maximum speed of the cutting attachment.
-  **LWA** Guaranteed sound power level in accordance with Directive 2000/14/EC in dB(A) for the purpose of comparing the sound emissions of products.
-  The information next to the symbol indicates the energy content of the battery according to the cell manufacturer's specification. The energy content available in operation is lower.
-  Operate the electric product in a dry place, indoors only.
-  Do not dispose of the product with your household waste.
-  Read and understand the user manual and keep it in a safe place for reference.

4 Safety Precautions

4.1 Warning Signs

4.1.1 Warning symbols

Meanings of warning signs and labels on the brushcutter, battery and charger:

-  Observe safety warnings and take the necessary precautions.
-  Read and understand the user manual and keep it in a safe place for reference.
-  Wear safety glasses.
-  Protect the brushcutter and charger against rain and dampness.



Comply with the safety instructions concerning ejected objects and take the necessary precautions.



Maintain a safe distance.



Remove the battery during work interruptions, transport, storage, maintenance or repair.



Protect the battery against heat and fire.



Protect the battery against rain and moisture and do not immerse it in liquids.

4.1.2 Deflector for mowing heads

Meanings of warning signs and labels on the deflector for mowing heads:



Use this deflector for mowing heads.



Do not use this deflector for brush knives.

4.2 Intended Use

The STIHL FSA 30.0 grass trimmer/lawn edge trimmer (brushcutter) is designed for mowing grass.

Never use the brushcutter in the rain.

The STIHL AS battery feeds the brushcutter with power.

▲ WARNING

- There is a risk that batteries and chargers that are not explicitly approved by STIHL for the brushcutter can cause fire or explosion. Persons may be seriously or fatally injured, and property may be damaged.
 - ▶ Use the brushcutter with a STIHL AK battery.
 - ▶ Recharge the STIHL AS battery with a STIHL AL 1 charger.
- Using the brushcutter, battery or charger for purposes for which they were not designed

can cause material damage and serious or fatal injuries.

- ▶ Use the brushcutter, battery and charger as described in this User Manual.

4.3 The Operator

▲ WARNING

- Users without adequate training or instruction cannot recognize or assess the risks involved in using the trimmer, battery and charger. The user or other persons may sustain serious or fatal injuries.



- ▶ Read, understand and save the instruction manual.

- ▶ If you pass the trimmer, battery and charger on to another person: Always give them the instruction manual.
- ▶ Make sure the user meets the following requirements:
 - The user must be rested.
 - The user must be in good physical condition and mental health to operate and work with the trimmer, battery and charger. If the user's physical, sensory or mental ability is restricted, he or she may work only under the supervision of or as instructed by a responsible person.
 - The user is able to recognize and assess the risks involved in using the trimmer, battery and charger.
 - The user must be of legal age or is being trained in a trade under supervision in accordance with national rules and regulations.
 - The user has received instruction from a STIHL servicing dealer or other

experienced user before working with the trimmer for the first time.

- The user must not be under the influence of alcohol, medication or drugs.
- ▶ If you have any queries: Contact a STIHL servicing dealer for assistance.

4.4 Clothing and equipment

▲ WARNING

- Objects can be thrown at high speed during operation. This may result in injury to the user.
 - ▶ Wear close-fitting safety glasses. Suitable safety glasses are tested in accordance with EN 166 or national regulations and available commercially with the corresponding marking.
- ▶ Wear face protection.
- ▶ Wear long trousers made from resistant material.
- Dust can be whipped up during operation. Whipped up dust can damage the respiratory passages and cause allergic reactions.
 - ▶ If dust is generated: Wear a dust respirator mask.
- Inappropriate clothing can snag on wood, brush or the brushcutter. Users not wearing suitable clothing are at risk of serious injury.
 - ▶ Wear close-fitting clothing.
 - ▶ Remove scarves and jewelry.
- The user may come into contact with the rotating cutting attachment during operation. This may result in serious injury to the user.
 - ▶ Wear robust footwear.
 - ▶ Wear long trousers made from resistant material.
- There is a risk of the user coming into contact with the cutting attachment or the line limiting blade during cleaning and maintenance work and when the cutting attachment is mounted or removed. This may result in injury to the user.
 - ▶ Wear work gloves made from resistant material.
- Wearing unsuitable footwear may cause the user to slip. This may result in injury to the user.
 - ▶ Wear sturdy, closed-toed footwear with high-grip soles.



4.5 Work Area and Surroundings

4.5.1 Brushcutter

▲ WARNING

- Bystanders, children and animals are not aware of the dangers of the brushcutter and objects being thrown into the air and cannot assess them. Bystanders, children and animals may be seriously injured and property may be damaged.



▶ Keep bystanders, children and animals at a distance of 15 m from the working area.

- ▶ Maintain a distance of 15 m from objects.
- ▶ Do not leave the brushcutter unattended.
- ▶ Ensure that children cannot play with the brushcutter.
- The brushcutter is not waterproof. If you work in the rain or in a damp environment, an electric shock may occur. The user may be injured and the brushcutter may be damaged.



▶ Do not work in the rain or in a damp environment.

- Electrical components of the brushcutter can produce sparks. Sparks can cause fires and explosions in a flammable or explosive environment. This can result in serious injuries or death and damage to property.
- ▶ Do not work in a flammable environment or in an explosive environment.

4.5.2 Battery

▲ WARNING

- Bystanders, children and animals cannot recognize or assess the dangers of the battery. Bystanders, children and animals may be seriously injured.
- ▶ Keep bystanders, children and animals away from the work area.
- ▶ Do not leave the battery unattended.
- ▶ Make sure that children cannot play with the battery.
- The battery is not protected against all ambient conditions. If the battery is exposed to certain ambient conditions, the battery may catch fire, explode or be irreparably damaged. This may result in serious injury to people and damage to property.



▶ Protect battery from heat and fire.
▶ Do not throw the battery into a fire.

- ▶ Do not charge, use and store the battery outside of the specified temperature limits, 20.5.



- ▶ Protect the battery from rain and moisture and do not immerse it in liquids.
- ▶ Keep battery away from small metal parts.
- ▶ Do not expose the battery to high pressure.
- ▶ Do not expose the battery to microwaves.
- ▶ Protect the battery from chemicals and salts.

4.5.3 Charger

▲ WARNING

- Bystanders and children are not aware of and cannot assess the dangers of a charger or electric current. Bystanders, children and animals may be seriously or fatally injured.
- ▶ Keep bystanders, children and animals away from the work area.
- ▶ **Make sure that children cannot play with the charger.**
- The charger is not waterproof. If you work in the rain or in a damp environment, an electric shock may occur. The user may be injured and the charger may be damaged.



▶ Do not operate it in the rain or in a damp environment.

- The charger is not protected against all ambient conditions. If the charger is exposed to certain ambient conditions, it may catch fire or explode. This may result in serious injury to people and damage to property.
- ▶ Operate the charger in an enclosed, dry room.
- ▶ Do not operate the charger in a flammable environment or in an explosive environment.
- ▶ Do not operate the charger on a readily combustible surface.
- ▶ Do not use and store the charger outside of the specified temperature limits, 20.5.
- The connecting cable is a trip hazard. People may be injured and the charger may be damaged.
- ▶ Lay the connecting cable flat on the floor.

4.6 Safe Condition

4.6.1 Brushcutter

The brushcutter is in a safe condition if the following points are observed:

- The brushcutter is not damaged.
- The brushcutter is clean and dry.
- The controls function properly and have not been modified.
- A combination of cutting attachment and deflector recommended in this user manual is mounted.
- The cutting attachment and deflector are properly mounted.
- Genuine STIHL accessories for this brushcutter are fitted.
- The accessories are correctly installed.

▲ WARNING

- If not in safe condition, components may no longer operate correctly and safety devices may be rendered ineffective. There is a risk of serious or fatal injury.
 - ▶ Work only with an undamaged brushcutter.
 - ▶ If the brushcutter is dirty or wet: Clean the brushcutter and allow it to dry.
 - ▶ Never attempt to modify your brushcutter. Exception: Mounting one of the combinations of cutting attachment and deflector recommended in this User Manual.
 - ▶ If the controls do not function properly: Do not use your brushcutter.
 - ▶ Never mount metal cutting attachments.
 - ▶ Fit genuine STIHL accessories for this brushcutter.
 - ▶ Mount the cutting attachment and deflector as described in this User Manual.
 - ▶ Install accessories as described in this user manual or in the user manual for the accessories.
 - ▶ Never insert objects into the openings of the brushcutter.
 - ▶ Replace worn or damaged labels.
 - ▶ If you are unsure: Consult a STIHL authorized dealer.

4.6.2 Deflector

The deflector is in a safe condition if the following points are observed:

- The deflector is not damaged.
- The line limiter blade is correctly installed.

▲ WARNING

- If the product does not comply with safety requirements, components will no longer function properly or safety devices may be ren-

dered inoperative. This can result in serious injuries.

- ▶ Work only with an undamaged deflector.
- ▶ Work with a correctly installed line limiter blade.
- ▶ If you have any queries: Contact your STIHL servicing dealer.

4.6.3 Mowing Head

The mowing head is in a safe condition if the following points are observed:

- The mowing head is not damaged.
- The mowing head is not jammed.
- The mowing head is correctly installed and firmly tightened.
- The mowing lines are properly installed.
- If a Polycut mowing head with polymer blades is used:
 - The polymer blades are free of damage and tears.
 - The polymer blades are properly mounted.
- The wear limits are not exceeded.

▲ WARNING

- If they are in an unsafe condition, parts of the mowing head, mowing lines or polymer blades may come off and be ejected at high speed. People may be seriously injured.
 - ▶ Work only with an undamaged mowing head.
 - ▶ If a PolyCut mowing head with polymer blades is used: Never work with damaged polymer blades.
 - ▶ Never use metal objects in place of the nylon mowing lines or polymer blades.
 - ▶ Observe and remain inside the wear limits.
 - ▶ If you are unsure: Consult a STIHL authorized dealer.

4.6.4 Battery

The battery is in a safe condition if the following points are observed:

- Battery is undamaged.
- The battery is clean and dry.
- Battery functions properly and has not been modified.

▲ WARNING

- A battery that is not in a safe condition cannot operate safely. Persons may be seriously injured.
 - ▶ Never work with a damaged battery.
 - ▶ Never attempt to charge a damaged or defective battery.
 - ▶ If the battery is dirty: Clean the battery.

- ▶ If the battery is wet or damp: Allow the battery to dry,  20.6.
- ▶ Never attempt to modify the battery.
- ▶ Never insert objects in the battery's openings.
- ▶ Never bridge the battery's contacts with metallic objects (short circuit).
- ▶ Do not open the battery.
- ▶ Replace worn or damaged labels.
- Fluid may leak from a damaged battery. If that liquid comes into contact with the skin or eyes, the skin or eyes may be irritated.
 - ▶ Avoid contact with the liquid.
 - ▶ If skin contact occurs: Wash affected areas of skin with plenty of water and soap.
 - ▶ In the event of contact with eyes: Rinse eyes with plenty of water for at least 15 minutes and consult a doctor.
- A damaged or defective battery may smell unusual, emit smoke or burn. Persons may be seriously or fatally injured, and property may be damaged.
 - ▶ If the battery smells unusual or emits smoke: do not use the battery and keep it away from combustible substances.
 - ▶ If the battery catches fire: Attempt to extinguish the battery with a fire extinguisher or water.

4.6.5 Charger

The charger is in a safe condition if the following points are observed:

- Charger is undamaged.
- Charger is clean and dry.

WARNING

- If components do not comply with safety requirements, they will no longer function properly and safety devices may be rendered inoperative. This can result in serious or fatal injuries.
 - ▶ Do not use a damaged charger.
 - ▶ If the charger is dirty or wet: Clean the charger and allow it to dry.
 - ▶ Never attempt to modify the charger.
 - ▶ Never insert objects in the charger's openings.
 - ▶ Never bridge the charger's contacts with metallic objects (short circuit).
 - ▶ Do not open the charger.

4.7 Working

WARNING

- In certain situations, the user may no longer be able to concentrate on their work. This may

- result in the user stumbling, falling and suffering serious injury.
 - ▶ Work carefully and calmly.
 - ▶ If light and visibility are poor: Do not use your trimmer.
 - ▶ Operate the trimmer alone.
 - ▶ Keep the cutting attachment close to the ground.
 - ▶ Watch out for obstacles.
 - ▶ Work standing on the ground and keep your balance.
 - ▶ If you feel tired, take a break.
- The rotating cutting attachment can cut the user. This may result in serious injury to the user.
 - ▶ Do not touch the rotating cutting attachment.
 - ▶ If the cutting attachment is blocked by an object: Switch off the brushcutter and remove the battery. Only then should you remove the object.
- If the behavior of the trimmer changes during operation or feels unusual, it may no longer be in a safe condition. There is a risk of serious injury to people and damage to property.
 - ▶ Stop working, remove the battery and consult a STIHL dealer.
- Vibrations may occur during brushcutter operation.
 - ▶ Wear gloves.
 - ▶ Take breaks.
 - ▶ If signs of a circulatory disturbance occur: Consult a doctor.
- If the cutting attachment makes contact with a foreign object during operation, the object or parts of it may be thrown at high speed. Persons may be injured or property damaged.
 - ▶ Remove foreign objects from the working area.
- If the rotating cutting attachment makes contact with a hard object, sparks may occur and the cutting attachment can be damaged. Sparks can cause fires in a flammable environment. Persons may be seriously or fatally injured and property may be damaged.
 - ▶ Do not use the tool in a flammable environment.
 - ▶ Make sure the cutting attachment is in a safe condition.
- Note that the cutting attachment continues to rotate for a short period after you release the trigger. There is a risk of serious injury to persons.
 - ▶ Wait until the cutting attachment comes to a complete stop.

4.8 Charging

▲ WARNING

- A damaged or defective charger may produce an unusual smell or emit smoke during the charging process. This may result in personal injuries and damage to property.
 - ▶ Disconnect the plug from the wall outlet.
- The charger can overheat and cause a fire if heat dissipation is inadequate. This can result in serious or fatal injuries and damage to property.
 - ▶ Do not cover the charger.

4.9 Connecting to the power supply

Contact with live components may occur for the following reasons:

- The connecting cable or the extension cord is damaged.
- The mains plug of the connecting cable or extension cord is damaged.
- The socket is not properly installed.

▲ DANGER

- Contact with live parts may result in electric shock. This may result in serious or fatal injury to the user.
 - ▶ Make sure that the connecting cable, extension cord and their mains plugs are undamaged.



If the connecting cable or the extension cord is damaged:

- ▶ Do not touch the damaged area.
 - ▶ Disconnect the mains plug from the power supply.
- ▶ Make sure your hands are dry before touching the connecting cable, extension cord or mains plugs.
 - ▶ Plug the mains plug of the connecting cable or extension cord into a properly installed, shockproof socket with the correct fuse rating.
 - ▶ Install the charger with a ground fault circuit interrupter (30 mA, 30 ms).
- A damaged or unsuitable extension cable can result in electric shock. There is a risk of serious or fatal injury.
 - ▶ Use an extension cable with the correct cable cross-section,  20.4.

▲ WARNING

- Overvoltage can occur in the charger if the line voltage or frequency are incorrect during charging. The charger may be damaged.
 - ▶ Make sure that the mains voltage and the mains frequency of the power supply match the data on the rating plate of the charger.
- If the charger is connected to a power strip, electrical components may be overloaded during the charging process. The components may overheat and cause a fire. Persons may be seriously or fatally injured, and property may be damaged.
 - ▶ Ensure that the technical specifications for the power strip are not exceeded by the information on the rating plate of the charger and of all electrical devices connected to the power strip.
- An incorrectly routed connecting cable or extension cord may be damaged, and people may trip over it. People may be injured, and the connecting cable or extension cord may be damaged.
 - ▶ Route and mark the connecting cable and extension cord so that people will not trip over them.
 - ▶ Route the connecting cable and extension cord so that they are not under tension or tangled.
 - ▶ Route the connecting cable and extension cord so that they will not be damaged, kinked or crushed and will not be chafed.
 - ▶ Protect the connecting cable and extension cord from heat, oil and chemicals.
 - ▶ Lay the connecting cable and extension cord on a dry surface.
- The extension cable warms up in operation. If that heat cannot escape, it may cause a fire.
 - ▶ If using a cable reel: completely unroll the cable reel.
- If wiring and pipes are laid in the wall, they may be damaged if the charger is mounted on the wall. Contact with wiring can result in electric shock. This may result in serious injury to people and damage to property.
 - ▶ Make sure there is no wiring or pipes in the wall at the proposed mounting site.
- If the charger is not mounted on the wall as described in this User Manual, the charger or the battery may fall or the charger may overheat. This may result in injury to people and damage to property.
 - ▶ Mount the charger on a wall as described in this User Manual.
- If the charger is mounted on a wall with the battery inserted, the battery may fall out of the charger. This may result in injury to people and damage to property.
 - ▶ Mount the charger on the wall first before inserting the battery.

4.10 Transporting

4.10.1 Trimmer

⚠ WARNING

- The trimmer may turn over or shift during transport. This may result in personal injuries and damage to property.



- ▶ Remove the battery.

- ▶ Secure the trimmer with lashing straps or a net to prevent it turning over and moving.

4.10.2 Battery

⚠ WARNING

- The battery is not protected against all ambient conditions. The battery may be damaged if it is exposed to certain ambient conditions, and damage to property may occur.
 - ▶ Never transport a damaged battery.
 - ▶ If a bag is supplied: Transport the battery in the bag supplied.
- The battery may turn over or shift during transport. This may result in injury to people and damage to property.
 - ▶ Pack the battery in packaging in such a way that it cannot move.
 - ▶ Secure the packaging so that it cannot move.

4.10.3 Charger

⚠ WARNING

- The charger can turn over or move while being transported. This may result in personal injuries and damage to property.
 - ▶ Disconnect the plug from the wall outlet.
 - ▶ Remove the battery.
 - ▶ Transport the charger in the bag supplied.
 - ▶ If no bag is supplied with the charger: Secure the charger with lashing straps, belts or a net to prevent it turning over and moving.
- The connecting cable must not be used for carrying the charger. The connecting cable and the charger may be damaged.
 - ▶ Wind up the connecting cable and attach it to the charger.

4.11 Storing

4.11.1 Trimmer

⚠ WARNING

- Children are not aware of and cannot assess the dangers of a trimmer and can be seriously injured.



- ▶ Remove the battery.

- ▶ Store the trimmer out of the reach of children.

- Dampness can corrode the electrical contacts on the trimmer and metal components. This can damage the trimmer.



- ▶ Remove the battery.

- ▶ Store the trimmer in a clean and dry condition.

4.11.2 Battery

⚠ WARNING

- Children are not aware of and cannot assess the dangers of the battery. Children may be seriously injured.
 - ▶ Store the battery out of the reach of children.
- The battery is not protected against all ambient conditions. If the battery is exposed to certain ambient conditions, the battery may be irreparably damaged.
 - ▶ Store the battery in a clean and dry condition.
 - ▶ Store the battery in an enclosed space.
 - ▶ Store the battery separately from the brush-cutter.
 - ▶ If the battery is stored in the charger, disconnect the mains plug and store the battery at a state of charge between 40% and 60% (2 lit green LEDs).
 - ▶ Do not store the battery outside of the specified temperature limits,  20.5.

4.11.3 Charger

⚠ WARNING

- Children are not aware of and cannot assess the dangers of a charger. Children can be seriously injured or killed.
 - ▶ Disconnect the plug from the wall outlet.
 - ▶ Store the charger out of reach of children.

- The charger is not protected against all ambient conditions. If the charger is exposed to certain ambient conditions, the charger may be damaged.
 - ▶ Disconnect the plug from the wall outlet.
 - ▶ If the charger is hot: Allow the charger to cool down.
 - ▶ Store the charger in a clean, dry place.
 - ▶ Store the charger in an enclosed room.
 - ▶ Do not store the charger outside of the specified temperature limits, [10](#) 20.5.
- The connecting cable should not be used for carrying the charger or hanging up the charger. The connecting cable and the charger may be damaged.
 - ▶ Hold the charger by the housing in a secure grip.
 - ▶ Hang the charger on the wall mounting.

4.12 Cleaning, Maintenance and Repair

▲ WARNING

- The brushcutter may start up unintentionally if the battery is left in place during cleaning, maintenance or repair operations. This may result in serious injury to people and damage to property.



- ▶ Remove the battery.

- Aggressive cleaning agents, a water jet or pointed objects can damage the trimmer, deflector, cutting attachment, battery and the charger. If the trimmer, deflector, cutting attachment, battery or charger are not cleaned correctly, components may no longer function properly or safety devices may be rendered inoperative. They may cause serious injury to persons.
 - ▶ Clean the trimmer, deflector, cutting attachment, battery and charger as described in this instruction manual.
- If the trimmer, deflector, cutting attachment, battery and charger are not properly serviced or repaired, components may no longer function properly or safety devices may be rendered inoperative. This may result in serious or fatal injury to people.
 - ▶ Do not attempt to service or repair the trimmer, deflector, cutting attachment, battery or charger.
 - ▶ If the trimmer, deflector, cutting attachment, battery or the charger require servicing or

repairs: Contact your STIHL servicing dealer for assistance.

5 Preparing Trimmer for Operation

5.1 Preparing the brushcutter for operation

The following steps must be performed before commencing work:

- ▶ Ensure that the following components are in a safe condition:
 - Brushcutter, [10](#) 4.6.1.
 - Deflector, [10](#) 4.6.2.
 - Mowing head, [10](#) 4.6.3.
 - Battery, [10](#) 4.6.4.
 - Charger, [10](#) 4.6.5.
- ▶ Check the battery, [10](#) 11.3.
- ▶ Fully charge the battery, [10](#) 6.2.
- ▶ Clean the brushcutter, [10](#) 16.1.
- ▶ Mount the spacer, [10](#) 7.1.
- ▶ Attach the deflector, [10](#) 7.2.
- ▶ Mount the loop handle, [10](#) 7.3.
- ▶ Fit the blades or mowing lines, [10](#) 7.5.1 or [10](#) 7.6.1.
- ▶ Adjust length of shaft, [10](#) 8.2.
- ▶ Adjust the loop handle, [10](#) 8.3.
- ▶ Check the controls, [10](#) 11.1.
- ▶ If you cannot carry out this work: Do not use your brushcutter and contact a STIHL authorized dealer for assistance.

6 Charging the Battery, LEDs

6.1 Mounting the Charger on a Wall

The charger can be mounted on a wall.

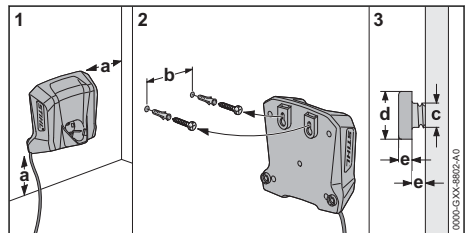

► Check the following points when mounting the charger on a wall:

- Suitable fixing materials.
- The charger is level.

The following dimensions are observed:

- a = at least 100 mm
- b = 54 mm
- c = 4.5 mm
- d = 9 mm
- e = 2.5 mm

6.2 Charging the battery

The charging time depends on various factors, e.g. the battery temperature or the ambient temperature. For optimum performance, observe the recommended temperature ranges,  20.6. The actual charging time may vary from the charging time indicated. The charging time is indicated at www.stihl.com/charging-times.

The charging process starts automatically when the mains plug is plugged into a socket and the battery is inserted into the charger. The charger switches off automatically when the battery is fully charged.

The battery and the charger warm up during charging.

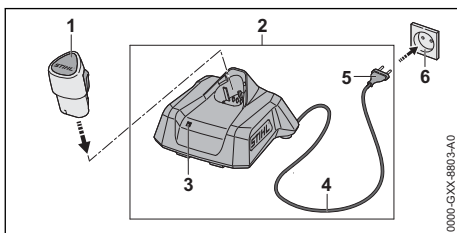

- Insert the mains plug (5) in a convenient wall outlet (6).
The charger (2) runs a self test. The LED (3) glows green for about 1 second and then red for about 1 second.
- Fit the connecting cable (4).
- Insert the battery (1) in the guides in the charger (2) and press it home as far as stop. The LED (3) glows or flashes green. The battery (2) is being charged.

- When the LED (3) stops glowing: The battery (1) is fully charged and can be taken out of the charger (2).
- If the charger (2) is no longer required. Disconnect the mains plug (5) from the wall outlet (6).

6.3 Displaying the State of Charge

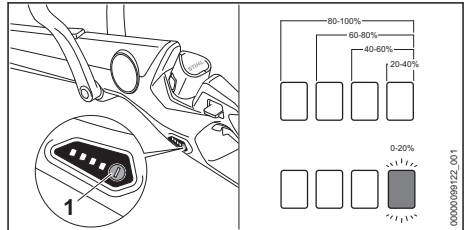

- Insert the battery.
- Depress the pushbutton (1).
The LEDs light up steady green for about 5 seconds and indicate the state of charge.
- If the LED on the right flashes green: Charge the battery.

6.4 LEDs on brushcutter

The LEDs can indicate the state of charge of the battery or any faults. The LEDs can may light up steady or flash in green or red.

If the LEDs light up steady or flash green, this indicates the state of charge of the battery.

- If the LEDs light up steady or flash red: Troubleshooting,  19.1.
Malfunction in brushcutter or battery.

6.5 LED on Charger

The LED indicates the operating status of the charger or faults. The LED can glow or flash green or red.

If the LED glows or flashes green, the battery is being charged.

- If the LED glows or flashes red: Troubleshooting,  19.1.
There is a malfunction in charger or battery.

7 Assembling the Trimmer

7.1 Mounting the bump guard

- Switch off the brushcutter and remove the battery.

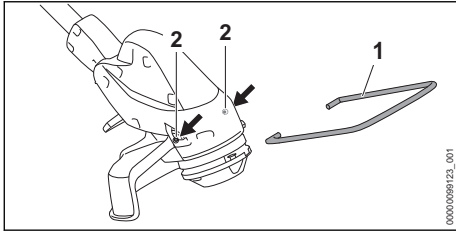

- ▶ Insert the ends of the bump guard (1) into the holes (2) in the housing.

The bump guard (1) need not be removed.

7.2 Attaching the deflector

- ▶ Switch off the brushcutter and remove the battery.

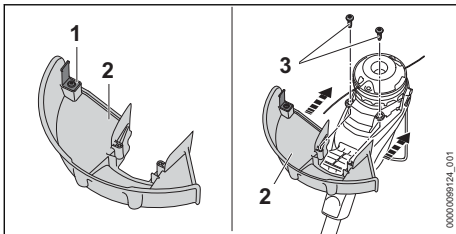

The line limiting blade (1) has already been installed in the guard (2) and must not be removed.

- ▶ Push the guard (2) into the guides on the housing until it hits the limit stop.
- ▶ The guard (2) is flush with the housing.
- ▶ Insert and tighten the screws (3).

The guard (2) must not be removed.

7.3 Mounting the loop handle

- ▶ Switch off the brushcutter and remove the battery.

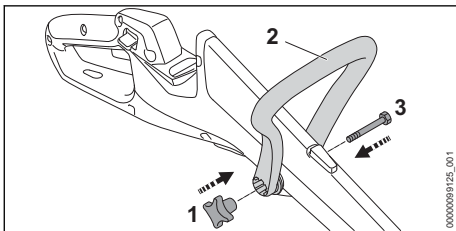

- ▶ Position the loop handle (2) so that the recess for the star knob nut (1) is on the right – viewed from the control handle.
- ▶ Ease the ends of the loop handle (2) apart and place the loop handle (2) on the control handle until the loop handle (2) snaps into place.

- ▶ Insert the screw (3) through the hole.
 - ▶ Fit the star knob nut (1) and tighten it down.
- The loop handle (2) must not be removed again.

7.4 Mounting and Removing the Mowing Head

7.4.1 Mounting the mowing head

- ▶ Switch off the brushcutter and remove the battery.

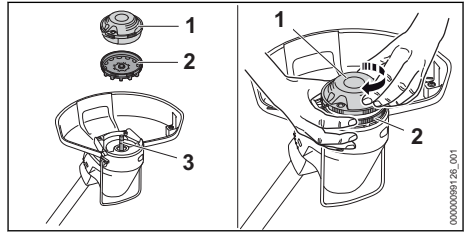

- ▶ Push the fanwheel (2) onto the shaft (3) until the vanes of the fanwheel (2) point downward.
- ▶ If the fanwheel is not fitted, the electric motor will not be cooled properly and the brushcutter will cut out during operation.
- ▶ Hold the fanwheel (2) steady with one hand.
- ▶ Fit the mowing head (1) on the shaft (3), turn it clockwise by hand and tighten it down firmly.

7.4.2 Removing the mowing head

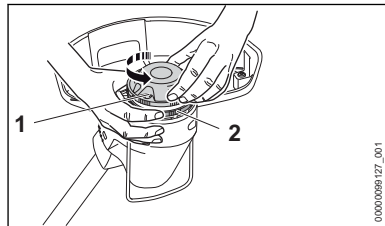

- ▶ Switch off the brushcutter and remove the battery.
- ▶ Hold the fanwheel (2) steady with one hand.
- ▶ Unscrew the mowing head (1) counterclockwise.
- ▶ Remove the fanwheel.

7.5 Attaching and removing the blade

7.5.1 Installing the blades

- ▶ Switch off the brushcutter and remove the battery.
- ▶ Place the blades in a container filled with water for 12 to 24 hours before using. This makes the blades supple.

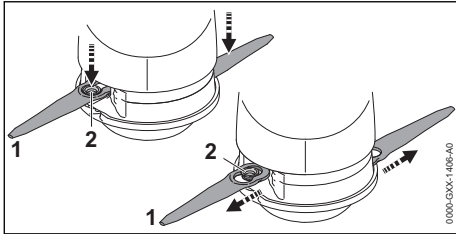

- ▶ Position the blade (1) on the mowing head so that the bushing (2) locates in the large bore in the blade (1).
- ▶ Pull the blade (1) outwards until the bushing (2) engages the small bore in the blade (1).

7.5.2 Removing the blades

- ▶ Switch off the brushcutter and remove the battery.

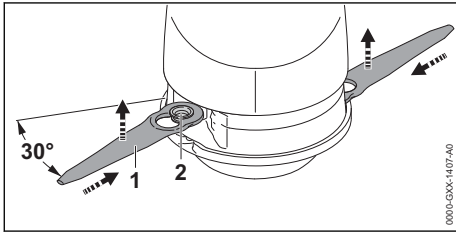

- ▶ Push the blade (1) inwards until the bushing (2) is released from the small bore in the blade (1).
- ▶ Remove the blade (1) upwards.

7.6 Attaching and removing the mowing line

7.6.1 Fitting mowing lines

- ▶ Switch off the brushcutter and remove the battery.
- ▶ Place mowing lines in a container filled with water for 12 to 24 hours before using. This makes the nylon mowing lines supple.

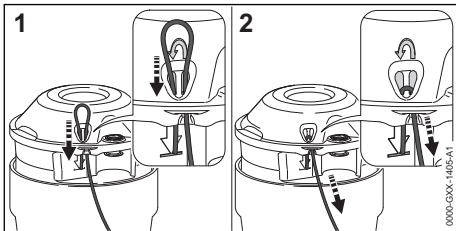

- ▶ Push the mowing line up through the right opening from below.

- ▶ Thread the mowing line through the left opening from above until the end of the line reaches the symbol.
- ▶ Hold the short end of the mowing line firmly.
- ▶ Pull the long end of the mowing line until it is tight against the mowing head.

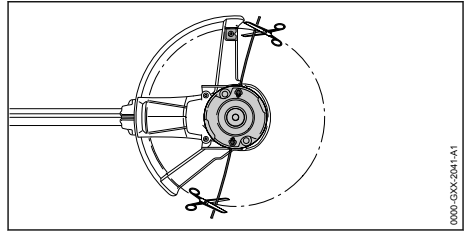

- ▶ Cut the mowing lines so that they extend as far as the line limiting blade.

7.6.2 Removing the mowing lines

- ▶ Switch off the brushcutter and remove the battery.
- ▶ Push the short end of the mowing line upwards out of the mowing head.
- ▶ Pull the short end of the mowing line upwards out of the mowing head.
- ▶ Pull the mowing line out of the mowing head.

8 Adjusting Trimmer for User

8.1 Adjusting the shaft angle

The shaft angle can be adjusted to suit the height and reach of the user.

- ▶ Switch off the brushcutter and remove the battery.

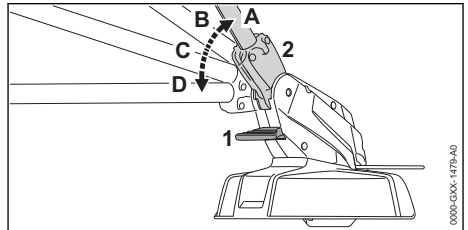

- ▶ Depress the lever (1) and hold it in that position.
- ▶ Move shaft (2) to the required position (A to D) until it engages.
- ▶ Release the lever (1).

8.2 Adjusting the shaft length

The length of the shaft can be adjusted to suit the height and reach of the user.

- ▶ Switch off the brushcutter and remove the battery.

- ▶ Hold on to the control handle.

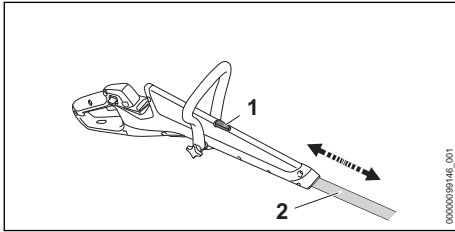

- ▶ Depress the locking button (1) and hold it in that position.
- ▶ Pull or push the shaft (2) to the required position.
- ▶ Release the locking button (1).
- ▶ Move the control handle (2) back and forth until it engages.

8.3 Adjusting the loop handle

The loop handle can be set in different positions to suit the height and reach of the user.

- ▶ Switch off the brushcutter and remove the battery.

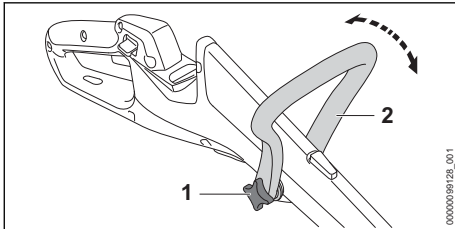

- ▶ Loosen the star knob nut (1).
- ▶ Tilt the loop handle (2) to the required position.
- ▶ Tighten down the star knob nut (1) firmly.

8.4 Converting the Brushcutter into an Edger

- ▶ Switch off the brushcutter and remove the battery.

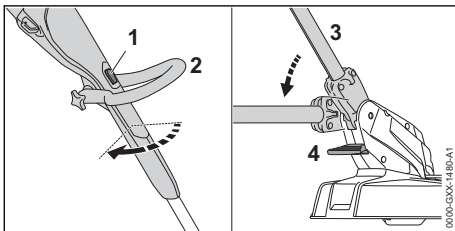

- ▶ Depress the locking button (1) and hold it in that position.
- ▶ Rotate the control handle (2) by 90° until it engages.

- ▶ Release the locking button (1).
- ▶ Depress the lever (4) and hold it in that position.
- ▶ Tilt the shaft (3) to its flattest position until it engages.
- ▶ Release the lever (4).

9 Removing and Fitting the Battery

9.1 Inserting the battery

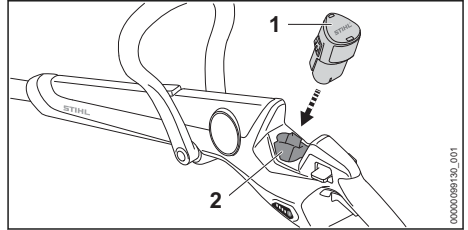

- ▶ Push the battery (1) into the battery compartment (2) as far as stop. The battery (1) engages in position with a click.

9.2 Removing the Battery

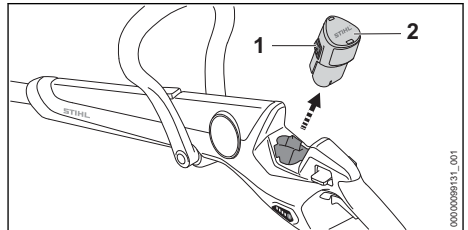

- ▶ Depress both locking hooks (1). The battery (2) is now unlocked and can be removed.

10 Switching the Trimmer On/Off

10.1 Switching on the brushcutter

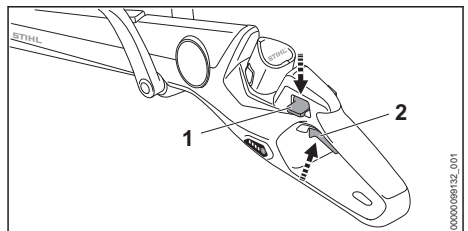

- ▶ Hold the brushcutter firmly with one hand on the control handle – wrap your thumb around the handle.
- ▶ Hold the brushcutter with the other hand on the loop handle such that your thumb holds the loop handle.
- ▶ Depress the lockout lever (1) with your thumb and hold it there.
- ▶ Squeeze and hold the trigger (2) with your index finger.
The brushcutter accelerates and the cutting attachment rotates. The locking lever (1) can be released.

10.2 Switching off the brushcutter

- ▶ Release the trigger.
- ▶ Wait for the cutting attachment to stop rotating.
- ▶ If the cutting attachment continues to rotate: Remove the battery and contact a STIHL authorized dealer.
The brushcutter is defective.

11 Testing the Trimmer and Battery

11.1 Checking the controls

Lockout lever and trigger

- ▶ Remove the battery.
- ▶ Try pressing the trigger without pressing the locking lever.
- ▶ If you can press the trigger: Stop using your brushcutter and contact a STIHL authorized dealer.
The locking lever is defective.
- ▶ Depress the locking lever and hold it in that position.
- ▶ Press and release the trigger.
- ▶ If the trigger is stiff or does not spring back to its idle position: Do not use your brushcutter and contact your STIHL authorized dealer for assistance.
The trigger has a malfunction.

Switching on the brushcutter

- ▶ Insert the battery.
- ▶ Depress the locking lever and hold it in that position.
- ▶ Depress and hold the trigger.
The cutting attachment rotates.
- ▶ If 3 LEDs are flashing red: Remove the battery and consult a STIHL authorized dealer.
The brushcutter has a malfunction.
- ▶ Release the trigger.

The cutting attachment stops rotating after a short period of time.

- ▶ If the cutting attachment continues to rotate: Remove the battery and contact a STIHL authorized dealer.
The brushcutter is defective.

11.2 Inspecting the cutting attachment

- ▶ Switch off the brushcutter and remove the battery.

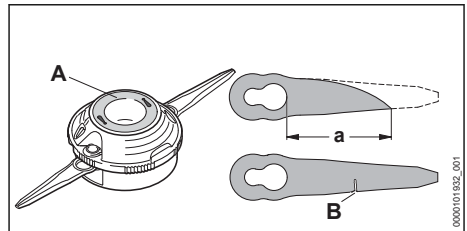

- ▶ If the wear mark (A) on the underside of the PolyCut 3-2 mowing head is visible: Do not use the brushcutter and replace the PolyCut 3-2 mowing head.
- ▶ If the length of one of the blades, measured from the large bore to the tip of the blade, is less than 'a' = 45 mm: Replace both blades.
- ▶ If one blade is damaged (B): Replace both blades.

11.3 Checking the battery

- ▶ Insert the battery.
- ▶ Depress the pushbutton on the brushcutter. The LEDs light up steady or flash.
- ▶ If the LEDs do not glow or flash: Do not use your brushcutter and battery and contact your STIHL servicing dealer.
Malfunction in brushcutter or battery.

12 Operating the Trimmer

12.1 Holding and Controlling the Trimmer

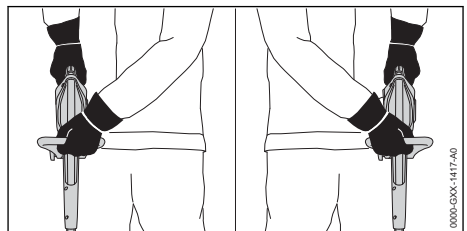

- ▶ Hold the trimmer with one hand on the control handle - wrap your thumb around the control handle.
- ▶ Hold the trimmer with the other hand on the loop handle - wrap your thumb around the loop handle.

12.2 Edging

- ▶ Convert the brushcutter to an edger.

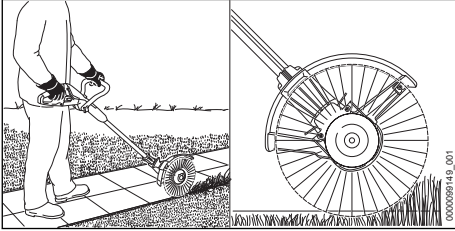

- ▶ Guide the brushcutter along the edge of the lawn.
- ▶ To maintain an even distances to the ground, extend the bump guard fully.

12.3 Mowing

The cutting height is determined by the distance of the cutting attachment from the ground.

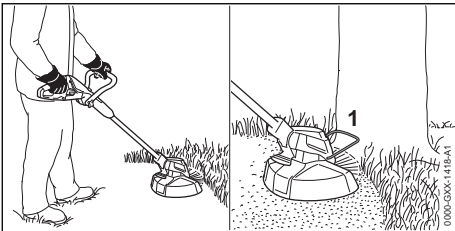

- ▶ Swing the brushcutter steadily back and forth in an arc.
- ▶ Walk forward slowly and steadily.
- ▶ If you work with a bump guard (1): Extend the bump guard (1) fully.

For optimum performance, note the recommended temperature ranges, 20.6.

12.4 Adjust the mowing lines on the AutoCut mowing heads

- ▶ Briefly tap the rotating mowing head on the ground.
About 30 mm of fresh nylon line is advanced. The line limiting blade in the deflector automatically cuts the mowing lines to the correct length.

Automatic feed will not take place if the mowing lines are shorter than 25 mm.

- ▶ Switch off the brushcutter and remove the battery.
- ▶ Press the button on the mowing head and hold it depressed.
- ▶ Pull out the mowing lines.
- ▶ If the mowing lines cannot be pulled out to required length: Install a new spool with mowing lines.
The spool is empty.

13 After Finishing Work

13.1 After Finishing Work

- ▶ Switch off the brushcutter and remove the battery.
- ▶ If the brushcutter is wet: Allow the brushcutter to dry.
- ▶ If the battery is moist or wet: Allow the battery to dry, 20.6.
- ▶ Clean the brushcutter.
- ▶ Clean the deflector.
- ▶ Clean the cutting attachment.
- ▶ Clean the battery.

14 Transporting

14.1 Transporting the brushcutter

- ▶ Switch off the brushcutter and remove the battery.

Carrying the Brushcutter

- ▶ Carry the brushcutter in one hand properly balanced by the shaft, with the cutting attachment behind you.

Transporting the brushcutter in the car

- ▶ Secure the brushcutter to prevent turnover and movement.

15 Storing

15.1 Storing the brushcutter

- ▶ Switch off the brushcutter and remove the battery.
- ▶ Ensure that the following conditions are met when storing the brushcutter:
 - The brushcutter cannot tip over or shift.
 - The brushcutter is out of the reach of children.
 - The brushcutter is clean and dry.
- ▶ If you store the brushcutter for more than 30 days: Remove the cutting attachment.

15.2 Storing the blades

Up to 6 blades can be stored directly on the brushcutter.

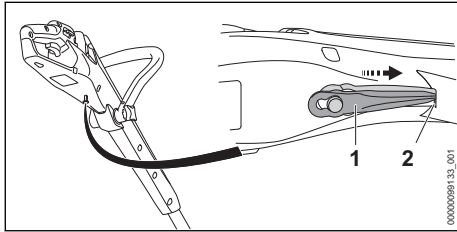

- ▶ Attach a blade (1) to the underside of the brushcutter.
- ▶ Push the tip of the blade (1) into the opening (2) in the brushcutter.
- ▶ Fit the next blade on top of the first and so on.

15.3 Storing the Battery

STIHL recommends keeping the battery in a charging state between 40% and 60 % (2 green LEDs lit).

- ▶ The battery should be stored in such a way that the following conditions are fulfilled:
 - The battery is out of the reach of children.
 - The battery is clean and dry.
 - The battery is in an enclosed space.
 - The battery is separated from the brushcutter.
 - If the battery is stored in the charger, disconnect the mains plug and store the battery at a state of charge between 40% and 60% (2 lit green LEDs).
 - Do not store the battery outside of the specified temperature limits, 20.5.

NOTICE

- If the battery is not stored as described in this User Manual, the battery may become deeply discharged and irreparably damaged.
 - ▶ Charge a discharged battery before storing it. STIHL recommends keeping the battery state of charge between 40% and 60% (2 lit green LEDs).
 - ▶ Store the battery separately from the brushcutter.

15.4 Storing the Charger

- ▶ Disconnect the mains plug from the power supply.

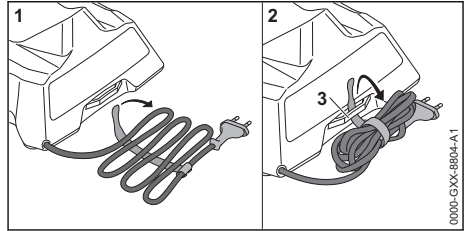

- ▶ Wind up the connecting cable and attach it to the charger.
- ▶ Observe the following points when storing the charger:
 - Charger is out of the reach of children.
 - The charger is clean and dry.
 - Charger is in an enclosed space.
 - The charger is not suspended from the connecting cable or the holder (3) for the connecting cable.
 - Do not store the charger outside of the specified temperature limits, 20.5.

16 Cleaning

16.1 Cleaning the Brushcutter

- ▶ Switch off the brushcutter and remove the battery.
- ▶ Clean the brushcutter with a damp cloth.
- ▶ Remove foreign objects from the battery compartment and clean the battery compartment with a damp cloth.
- ▶ Clean the electrical contacts in the battery compartment with a paintbrush or soft brush.
- ▶ Clean the area underneath the fanwheel with a soft brush.

16.2 Cleaning the Deflector and Cutting Attachment

- ▶ Switch off the trimmer and remove the battery.
- ▶ Clean the deflector and cutting attachment with a damp cloth or a soft brush.

16.3 Cleaning the Battery

- ▶ Clean the battery with a damp cloth.

16.4 Cleaning the Charger

- ▶ Disconnect the mains plug from the power supply.
- ▶ Clean the charger with a damp cloth.
- ▶ Clean the charger's electrical contacts with a paintbrush or a soft brush.

17 Maintenance

17.1 Maintenance Intervals

The maintenance intervals are dependent on the environmental and operating conditions. STIHL recommends the following maintenance intervals:

Every 12 months

- ▶ Have the trimmer checked by a STIHL servicing dealer.

18 Repairing



18.1 Repairing the Trimmer, Battery and Charger

The trimmer, cutting attachment, battery and charger are not user serviceable.

- ▶ If the trimmer or cutting attachment is damaged: Do not use your trimmer or cutting

19 Troubleshooting

19.1 Troubleshooting the brushcutter or battery

Malfunction	LEDs on the brushcutter	Cause	Remedy
The brushcutter does not start when switched on.	1 LED flashes green.	The charge level of the brushcutter is too low.	▶ Charge the battery.
	1 LED lights up steady red.	The battery is too warm or too cold.	▶ Remove the battery. ▶ Allow the battery to cool down or warm up.
	3 LEDs flash red.	The brushcutter is too hot.	▶ Remove the battery. ▶ Allow the brushcutter to cool down.
	4 LEDs flash red.	There is a fault in the battery.	▶ Remove the battery. ▶ Clean the electrical contacts in the battery compartment. ▶ Insert the battery. ▶ Switch on the brushcutter. ▶ If 4 LEDs continue to flash red: Do not use the battery; contact a STIHL authorized dealer.
		No electrical contact between brushcutter and battery.	▶ Remove the battery. ▶ Clean the electrical contacts in the battery compartment. ▶ Insert the battery.
		The brushcutter or battery is damp.	▶ Allow the brushcutter or battery to dry,  20.6.
		The cutting attachment is stuck.	▶ Remove the battery. ▶ Clean the brushcutter,  16.1.
The brushcutter cuts out during operation.	3 LEDs light up steady red.	The brushcutter is too hot.	▶ Remove the battery. ▶ Allow the brushcutter to cool down.
		There is an electrical fault.	▶ Remove the battery and reinsert it. ▶ Switch on the brushcutter.

attachment and contact your STIHL servicing dealer.

- ▶ If the battery has a malfunction or is damaged: Replace the battery.
- ▶ If the charger has a malfunction or is damaged: Replace the charger.
- ▶ If the connecting cable has a malfunction or is damaged: Do not use the charger and have connecting cable replaced by a STIHL servicing dealer.

Malfunction	LEDs on the brushcutter	Cause	Remedy
The runtime of the brushcutter is too short.		The battery is not fully charged.	► Fully charge the battery.
		The battery service life has been exceeded.	► Replace the battery
The mowing head cannot be removed by hand.		The mowing head is overtightened.	► Block the fanwheel with the stop pin. ► Unscrew the mowing head by hand. ► Remove the stop pin.

19.2 Troubleshooting the Charger

Fault	LED on Charger	Cause	Remedy
Battery not being charged.	One LED glows red.	The battery is too warm or too cold.	► Leave battery inserted in charger. Charging starts automatically as soon as the permitted temperature range is reached.
	The LED flashes red.	No electrical contact between charger and battery.	► Remove the battery. ► Clean contacts on charger. ► Insert battery.
		There is a malfunction in the charger.	► Do not use the charger and contact your STIHL dealer for assistance.
		There is a fault in the battery.	► Do not use the battery. Consult a STIHL dealer.
The charger does not run a self test.	The LED glows green for about 1 second and then red for about 1 second.	Electrical contact to charger was briefly interrupted.	► Disconnect the mains plug from the power supply. ► Wait for 1 minute. ► Insert the mains plug in a wall outlet.

20 Specifications

20.1 STIHL Brushcutter

- Approved battery: STIHL AS
- Weight without battery, with cutting tool and with deflector: 2.1 kg
- Length without cutting attachment: 1160 mm up to 1340 mm

For runtime, see www.stihl.com/battery-life.

20.2 STIHL AS Battery

- Battery Technology: Lithium-ion
- Voltage: 10.8 V
- Capacity in Ah: see rating label
- Energy content in Wh: see rating label
- Weight in kg: see rating label

20.3 STIHL AL 1 Charger

- Rated voltage: see rating plate
- Frequency: see rating plate
- Rated power: see rating plate
- Charging current: see rating plate

- Maximum energy content of approved STIHL AS battery: 12.5 Ah

For charging times see www.stihl.com/charging-times.

20.4 Extension Cords

If an extension cord is used, the cross sectional area of its conductors must meet the following minimum requirements – depending on the line voltage and length of the extension cord:

If rated voltage on the rating label is 220V to 240V:

- Cord length up to 20 m: AWG 15 / 1.5 mm²
- Cord length 20 m up to 50 m: AWG 13 / 2.5 mm²

If rated voltage on the rating label is 100V to 127V:

- Cord length up to 10 m: AWG 14 / 2.0 mm²
- Cord length 10 m up to 30 m: AWG 12 / 3.5 mm²

20.5 Temperature limits



- The battery is not protected against all ambient conditions. If the battery is exposed to certain environmental conditions, it may catch fire or explode. This may result in serious injury to people and damage to property.
 - ▶ Do not charge the battery below -20°C or above $+50^{\circ}\text{C}$.
 - ▶ Do not use the brushcutter, battery or charger below -20°C or above $+50^{\circ}\text{C}$.
 - ▶ Do not store the brushcutter, battery or charger below -20°C or above $+70^{\circ}\text{C}$.

20.6 Recommended temperature ranges

For optimum performance of the brushcutter, battery and charger, observe the following temperature ranges:

- Charging: 5°C to 40°C
- Use: -10°C to $+40^{\circ}\text{C}$
- Storage: -20°C to $+50^{\circ}\text{C}$

If the battery is charged, used or stored outside the recommended temperature ranges, performance may be reduced.

If the battery is wet or moist, allow the battery to dry for at least 48 h between 15°C and 50°C and with less than 70% humidity. Higher humidity may extend the drying time.

20.7 Sound Values and Vibration Values

The K value for the sound pressure level is 2 dB(A). The K value for the sound power level is 2 dB(A). The K-value for vibration level is 2 m/s^2 .

STIHL recommends wearing hearing protection.

- Sound pressure level L_{pA} measured in accordance with IEC 62841-4-4: 76 dB(A)
- Sound power level L_{WA} measured in accordance with IEC 62841-4-4: 89 dB(A)
- Vibration value a_{hv} measured in accordance with IEC 62841-4-4:
 - Control handle: 4.8 m/s^2
 - Load handle: 3.6 m/s^2

The vibration levels indicated were measured according to a standardized test method and can be used as a basis for comparing electric power tools. The vibration levels actually occurring may vary from the values indicated, depending on the type of application. The vibration levels indicated can be used for an initial estimate of the vibration

load. The actual vibration load has to be estimated. The times can be taken into account in the estimate when the electric power tool is switched off and also when it is switched on but running without any load.

For information on compliance with the Physical Agents (Vibration) Directive 2002/44/EC, see www.stihl.com/vib.

20.8 REACH

REACH is an EC regulation and stands for the Registration, Evaluation, Authorisation and Restriction of Chemical substances.

For information on compliance with the REACH regulation see www.stihl.com/reach.

21 Combinations of Cutting Attachments and Deflectors

21.1 STIHL brushcutter FSA 30.0

The following mowing heads may be mounted with the deflector:

- PolyCut 3-2 mowing head
 - with blades ($\varnothing 230\text{ mm}$)
 - with 1.6 mm diameter “round, quiet” mowing line ($\varnothing 250\text{ mm}$)
- AutoCut C 3-2 mowing head ($\varnothing 250\text{ mm}$)
 - with 1.6 mm diameter “round, quiet” mowing line

Using a mowing head with mowing lines may shorten the battery runtime.

22 Spare Parts and Accessories

22.1 Spare parts and accessories

STIHL  These symbols indicate original STIHL spare parts and original STIHL accessories.

STIHL recommends the use of original STIHL spare parts and accessories.

Despite ongoing market observation, STIHL is unable to judge the reliability, safety and suitability of other manufacturers' spare parts and accessories; accordingly, STIHL cannot warrant for the use of those parts.

Original STIHL spare parts and original STIHL accessories are available from STIHL dealers.

23 Disposal

23.1 Disposal of Brushcutter, Battery and Charger

Contact the local authorities or your STIHL dealer for information on disposal.

Improper disposal can be harmful to health and pollute the environment.

- ▶ Take STIHL products including packaging to a suitable collection point for recycling in accordance with local regulations.
- ▶ Do not dispose with domestic waste.

24 EC Declaration of Conformity

24.1 STIHL brushcutter FSA 30.0

ANDREAS STIHL AG & Co. KG
Badstraße 115
D-71336 Waiblingen
Germany

declares under its sole responsibility that

- Designation/machine category: Cordless grass trimmer/lawn edge trimmer
- Manufacturer's brand: STIHL
- Model: STIHL FSA 30.0
- Serial identification number: FA10

conforms to the relevant provisions of Directives 2011/65/EU, 2006/42/EC, 2014/30/EU and 2000/14/EC and has been developed and manufactured in compliance with the following standards in the versions valid on the date of production: EN 55014-1, EN 55014-2, EN 62841-1 and ISO 12100, taking into consideration IEC 62841-4-4, EN 60335-1 and EN 50636-2-91.

The measured and guaranteed sound power levels were determined according to Directive 2000/14/EC, Annex VI.

Participating notified body: VDE Prüf- u. Zertifizierungsinstitut (NB 0366), Merianstraße 28, 63069 Offenbach, Germany

- Measured sound power level: 89 dB(A)
- Guaranteed sound power level: 91 dB(A)

The technical documents are stored at ANDREAS STIHL AG & Co. KG Produktzulassung.

The year of manufacture, country of manufacture and machine number are specified on the rating plate of the brushcutter.

Waiblingen, 01-07-2023

ANDREAS STIHL AG & Co. KG

pp 

Robert Olma, Vice President, Regulatory Affairs & Global Governmental Relations

25 UKCA Declaration of Conformity

25.1 STIHL brushcutter FSA 30.0

**UK
CA**

ANDREAS STIHL AG & Co. KG
Badstraße 115
D-71336 Waiblingen
Germany

declares under its sole responsibility that

- Designation/machine category: Cordless grass trimmer/lawn edge trimmer
- Manufacturer's brand: STIHL
- Model: STIHL FSA 30.0
- Serial identification number: FA10

complies with the relevant provisions of the UK regulations The Restriction of the Use of Certain Hazardous Substances in Electrical and Electronic Equipment Regulations 2012, Supply of Machinery (Safety) Regulations 2008, Electromagnetic Compatibility Regulations 2016 and Noise Emission in the Environment by Equipment for use Outdoors Regulations 2001 and has been developed and manufactured in accordance with the versions of the following standards valid on the date of manufacture: EN 55014-1, EN 55014-2, EN 62841-1 and ISO 12100 taking into account IEC 62841-4-4, EN 60335-1 and EN 50636-2-91.

Applied conformity assessment procedure in accordance with UK regulations Noise Emission in the Environment by Equipment for use Outdoors Regulations 2001, Schedule 9.

Notified Body involved: AnP Certification Limited, 2 Parkfield Street, Rusholme, Manchester M 14 4PN

- Measured sound power level: 89 dB(A)
- Guaranteed sound power level: 91 dB(A)

The technical documentation is stored at ANDREAS STIHL AG & Co. KG.

The year of manufacture, country of manufacture and machine number are specified on the rating plate of the brushcutter.

Waiblingen, 01-07-2023

ANDREAS STIHL AG & Co. KG

pp 

Robert Olma, Vice President, Regulatory Affairs & Global Governmental Relations

26 General Power Tool Safety Warnings

26.1 Introduction

This chapter reproduces the pre-formulated, general safety precautions specified in the IEC 62841 standard for hand-held motor-operated electric tools.

STIHL is obliged to publish these texts.

The safety precautions and warnings on avoiding an electric shock given under "Electrical Safety" do not apply to STIHL cordless products.

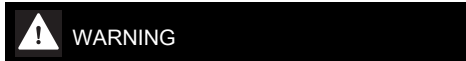

- **Read all safety warnings, instructions, illustrations and specifications provided with this power tool.** Failure to follow all instructions listed below may result in electric shock, fire and/or serious injury. **Save all warnings and instructions for future reference.**

The term "electric power tool" in the safety warnings refers to mains-operated (corded) power tools or battery-operated (cordless) power tools.

26.2 Work area safety

- a) **Keep work area clean and well lit.** Cluttered or dark areas invite accidents.
- b) **Do not operate power tools in explosive atmospheres, such as in the presence of flammable liquids, gases or dust.** Power tools create sparks which may ignite the dust or fumes.
- c) **Keep children and bystanders away while operating a power tool.** Distractions can cause you to lose control.

26.3 Electrical safety

- a) **Power tool plugs must match the outlet. Never modify the plug in any way. Do not**

use any adapter plugs with earthed (grounded) power tools. Unmodified plugs and matching outlets will reduce risk of electric shock.

- b) **Avoid body contact with earthed or grounded surfaces, such as pipes, radiators, ranges and refrigerators.** There is an increased risk of electric shock if your body is earthed or grounded.
- c) **Do not expose power tools to rain or wet conditions.** Water entering a power tool will increase the risk of electric shock.
- d) **Do not abuse the cord. Never use the cord for carrying, pulling or unplugging the power tool. Keep cord away from heat, oil, sharp edges or moving parts.** Damaged or entangled cords increase the risk of electric shock.
- e) **When operating a power tool outdoors, use an extension cord suitable for outdoor use.** Use of a cord suitable for outdoor use reduces the risk of electric shock.
- f) **If operating a power tool in a damp location is unavoidable, use a residual current device (RCD) protected supply.** Use of an RCD reduces the risk of electric shock.

26.4 Personal safety

- a) **Stay alert, watch what you are doing and use common sense when operating a power tool. Do not use a power tool while you are tired or under the influence of drugs, alcohol or medication.** A moment of inattention while operating power tools may result in serious personal injury.
- b) **Use personal protective equipment. Always wear eye protection.** Protective equipment such as a dust mask, non-skid safety shoes, hard hat or hearing protection used for appropriate conditions will reduce personal injuries.
- c) **Prevent unintentional starting. Ensure the switch is in the off-position before connecting to power source and/or battery pack, picking up or carrying the tool.** Carrying power tools with your finger on the switch or energising power tools that have the switch on invites accidents.
- d) **Remove any adjusting key or wrench before turning the power tool on.** A wrench or a key left attached to a rotating part of the power tool may result in personal injury.
- e) **Do not overreach. Keep proper footing and balance at all times.** This enables better con-

trol of the power tool in unexpected situations.

- f) **Dress properly. Do not wear loose clothing or jewellery. Keep your hair and clothing away from moving parts.** Loose clothes, jewellery or long hair can be caught in moving parts.
- g) **If devices are provided for the connection of dust extraction and collection facilities, ensure these are connected and properly used.** Use of dust collection can reduce dust-related hazards.
- h) **Do not let familiarity gained from frequent use of tools allow you to become complacent and ignore tool safety principles.** A careless action can cause severe injury within a fraction of a second.

26.5 Power tool use and care

- a) **Do not force the power tool. Use the correct power tool for your application.** The correct power tool will do the job better and safer at the rate for which it was designed.
- b) **Do not use the power tool if the switch does not turn it on and off.** Any power tool that cannot be controlled with the switch is dangerous and must be repaired.
- c) **Disconnect the plug from the power source and/or remove the battery pack, if detachable, from the power tool before making any adjustments, changing accessories, or storing power tools.** Such preventive safety measures reduce the risk of starting the power tool accidentally.
- d) **Store idle power tools out of the reach of children and do not allow persons unfamiliar with the power tool or these instructions to operate the power tool.** Power tools are dangerous in the hands of untrained users.
- e) **Maintain power tools and accessories. Check for misalignment or binding of moving parts, breakage of parts and any other condition that may affect the power tool's operation. If damaged, have the power tool repaired before use.** Many accidents are caused by poorly maintained power tools.
- f) **Keep cutting tools sharp and clean.** Properly maintained cutting tools with sharp cutting edges are less likely to bind and are easier to control.
- g) **Use the power tool, accessories and tool bits etc. in accordance with these instructions, taking into account the working conditions and the work to be performed.** Use of the

power tool for operations different from those intended could result in a hazardous situation.

- h) **Keep handles and grasping surfaces dry, clean and free from oil and grease.** Slippery handles and grasping surfaces do not allow for safe handling and control of the tool in unexpected situations.

26.6 Battery tool use and care

- a) **Recharge only with the charger specified by the manufacturer.** A charger that is suitable for one type of battery pack may create a risk of fire when used with another battery pack.
- b) **Use power tools only with specifically designated battery packs.** Use of any other battery packs may create a risk of injury and fire.
- c) **When battery pack is not in use, keep it away from other metal objects, like paper clips, coins, keys, nails, screws or other small metal objects, that can make a connection from one terminal to another.** Shorting the battery terminals together may cause burns or a fire.
- d) **Under abusive conditions, liquid may be ejected from the battery; avoid contact. If contact accidentally occurs, flush with water. If liquid contacts eyes, additionally seek medical help.** Liquid ejected from the battery may cause irritation or burns.
- e) **Do not use a battery pack or tool that is damaged or modified.** Damaged or modified batteries may exhibit unpredictable behaviour resulting in fire, explosion or risk of injury.
- f) **Do not expose a battery pack or tool to fire or excessive temperature.** Exposure to fire or temperature above 130 °C may cause explosion.
- g) **Follow all charging instructions and do not charge the battery pack or tool outside the temperature range specified in the instructions.** Charging improperly or at temperatures outside the specified range may damage the battery and increase the risk of fire.

26.7 Service

- a) **Have your power tool serviced by a qualified repair person using only identical replacement parts.** This will ensure that the safety of the power tool is maintained.
- b) **Never service damaged battery packs.** Service of battery packs should only be per-

formed by the manufacturer or authorized service providers.

26.8 Lawn Trimmer and Lawn Edge Trimmer Safety Warnings

- a) **Do not use the machine in bad weather conditions, especially when there is a risk of lightning.** This increases the risk of being struck by lightning.
- b) **Thoroughly inspect the area for wildlife where the machine is to be used.** Wildlife may be injured by the machine during operation.
- c) **Thoroughly inspect the area where the machine is to be used and remove all stones, sticks, wires, bones, and other foreign objects.** Thrown objects can cause personal injury.
- d) **Before using the machine, always visually inspect to see that the cutter and the cutter assembly are not damaged.** Damaged parts increase the risk of injury.
- e) **Before use, check the supply cord and any extension cord for signs of damage or aging. Do not use the machine if the cord is damaged or worn. If the cord is damaged or worn during use, switch off the machine and do not touch the cord before disconnecting it from the supply.** A damaged supply cord or extension cord may result in electric shock, fire and/or serious injury.
- f) **Check the grass collector frequently for wear or deterioration.** A worn or damaged grass collector may increase the risk of personal injury.
- g) **Keep guards in place. Guards must be in working order and be properly mounted.** A guard that is loose, damaged, or is not functioning correctly may result in personal injury
- h) **Keep all cooling air inlets clear of debris.** Blocked air inlets and debris may result in overheating or risk of fire.
- i) **Wear eye protection and ear protection.** Adequate protective equipment will reduce personal injury.
- j) **While operating the machine, always wear non-slip and protective footwear. Do not operate the machine when barefoot or wearing open sandals.** This reduces the chance of injury to the feet from contact with the moving cutters.
- k) **Always wear clothing such as trousers that covers the operator's legs while operating the machine.** Contact with the moving cutter or line may cause injury.
- l) **Keep bystanders away while operating the machine.** Thrown debris can result in serious personal injury.
- m) **Do not operate the machine above waist height.** This helps prevent unintended cutter contact and enables better control of the machine in unexpected situations.
- n) **Exercise caution when operating the machine in wet grass. Walk, never run.** This reduces the risk of slipping and falling which may result in personal injury.
- o) **Do not operate the machine on excessively steep slopes.** This reduces the risk of loss of control, slipping and falling which may result in personal injury.
- p) **When working on slopes, always be sure of your footing, always work across the face of slopes, never up or down and exercise extreme caution when changing direction.** This reduces the risk of loss of control, slipping and falling which may result in personal injury.
- q) **Keep all power cords and cables away from cutting area.** Power cords or cables may be hidden in hedges or bushes and can be accidentally cut or damaged by the line or cutter.
- r) **Keep all parts of the body away from the moving cutter or line. Do not clear material from the machine until it has been disconnected from the power source.** The moving trimmer cutter or line may result in serious personal injury.
- s) **Carry the machine with the machine switched off and away from your body.** Proper handling of the machine will reduce the likelihood of accidental contact with a moving trimmer cutter or line.
- t) **Only use replacement cutting heads and trimmer cutters or lines specified by the manufacturer. Do not replace the trimmer cutters or lines with metal wires or blades.** Incorrect replacement parts may cause loss of control, breakage and injury.

www.stihl.com



0458-039-0101-A



0458-039-0101-A