

MS 171, 181, 211

STIHL



2 - 45 Instruction Manual



Contents

1	Guide to Using this Manual.....	2
2	Safety Precautions.....	3
3	Reactive Forces.....	7
4	Working Techniques.....	8
5	Cutting Attachment.....	15
6	Mounting the Bar and Chain (side chain tensioner).....	15
7	Mounting the Bar and Chain (quick chain tensioner).....	16
8	Tensioning the Saw Chain (side chain tensioner).....	18
9	Tensioning the Saw Chain (quick chain tensioner).....	18
10	Checking Chain Tension.....	19
11	Fuel.....	19
12	Fueling.....	20
13	Chain Lubricant.....	23
14	Filling Chain Oil Tank.....	24
15	Checking Chain Lubrication.....	24
16	Chain Brake.....	24
17	Winter Operation.....	25
18	Starting / Stopping the Engine.....	26
19	Operating Instructions.....	30
20	Taking Care of the Guide Bar.....	31
21	Shroud.....	31
22	Air Filter System.....	31
23	Cleaning the Air Filter.....	32
24	Adjusting the Carburetor.....	32
25	Spark Plug.....	33
26	Engine Running Behavior.....	34
27	Storing the Machine.....	34
28	Checking and Replacing the Chain Sprocket.....	34
29	Maintaining and Sharpening the Saw Chain.....	35
30	Maintenance and Care.....	39
31	Minimize Wear and Avoid Damage.....	41
32	Main Parts.....	41
33	Specifications.....	42
34	Ordering Spare Parts.....	43
35	Maintenance and Repairs.....	44
36	Disposal.....	44
37	EC Declaration of Conformity.....	44
38	UKCA Declaration of Conformity.....	45

1 Guide to Using this Manual

This Instruction Manual refers to a STIHL chain saw, also called a machine in this Instruction Manual.

1.1 Pictograms

Pictograms that appear on the machine are explained in this Instruction Manual.

Depending on the machine and equipment version, the following pictograms may appear on the machine.



Fuel tank; fuel mixture of gasoline and engine oil



Tank for chain oil; chain oil



Engage and release chain brake



Coasting brake



Direction of chain travel



Ematic; chain oil flow adjustment



Tension saw chain



Intake air baffle: winter operation



Intake air baffle: summer operation



Handle heating



Actuate decompression valve



Actuate manual fuel pump

1.2 Symbols in text



WARNING

Warning where there is a risk of an accident or personal injury or serious damage to property.

NOTICE

Caution where there is a risk of damaging the machine or its individual components.

1.3 Engineering improvements

STIHL's philosophy is to continually improve all of its products. For this reason we may modify the design, engineering and appearance of our products periodically.

Therefore, some changes, modifications and improvements may not be covered in this manual.

2 Safety Precautions



Special safety precautions must be observed to reduce the risk of personal injury when working with a chain saw because of the very high chain speed and very sharp cutters.



It is important that you read the instruction manual before first use and keep it in a safe place for future reference. Non-observance of the instruction manual may result in serious or even fatal injury.

2.1 General

Observe all applicable local safety regulations, standards and ordinances.

The use of noise emitting power tools may be restricted to certain times by national or local regulations.

If you have not used this model before: Have your dealer or other experienced user show you how to operate your machine or attend a special course in its operation.

Minors should never be allowed to use a chain saw.

Keep bystanders, especially children, and animals away from the work area.

The user is responsible for avoiding injury to third parties or damage to their property.

Do not lend or rent your chain saw without the instruction manual. Be sure that anyone using it

understands the information contained in this manual.

To operate a chain saw you must be rested, in good physical condition and mental health. If you have any condition that might be aggravated by strenuous work, check with your doctor before operating a chain saw.

Do not operate the chain saw if you are under the influence of any substance (drugs, alcohol) which might impair vision, dexterity or judgment.

To reduce the risk of accidents or injury, put off the work in poor weather conditions (rain, snow, ice, wind).

Persons with pacemakers only: The ignition system of your chain saw produces an electromagnetic field of a very low intensity. This field may interfere with some pacemakers. To reduce health risks, STIHL recommends that persons with pacemakers consult their physician and the pacemaker manufacturer before operating this power tool.

2.2 Intended use

The machine may only be used to saw wood and wooden objects.

Do not use the machine for any other purpose – risk of accidents!

Do not modify the machine in any way – this may increase the risk of personal injury. STIHL excludes all liability for personal injury and damage to property caused while using unauthorised attachments.

2.3 Clothing and Equipment

Wear proper protective clothing and equipment.



Clothing must be sturdy and snug-fitting, but allow complete freedom of movement. Wear snug fitting clothing with **cut-retardant pads** – no loose-fitting jacket.

Avoid clothing that could get caught on branches, brush or moving parts of the machine. Do not wear a scarf, necktie or jewellery. Tie up and confine long hair (headscarf, cap, hard hat, etc.).



Wear suitable **safety shoes** – with cut-retardant material, non-slip soles and steel toe caps.

**WARNING**

To reduce the risk of eye injuries, wear tight-fitting safety goggles conforming to standard EN 166 or a face shield. Make sure that the safety goggles and the face shield fit correctly.

Wear "personal" hearing protection – for example, ear defenders.

Wear a hard hat wherever there is any risk of falling objects.



Wear sturdy protective gloves made of a resistant material (e.g. leather).

STIHL can supply a comprehensive range of personal protective equipment.

2.4 Transporting

Before any transport – even over short distances – switch off the machine, engage the chain brake and attach the chain scabbard. This avoids the risk of the saw chain starting unintentionally.

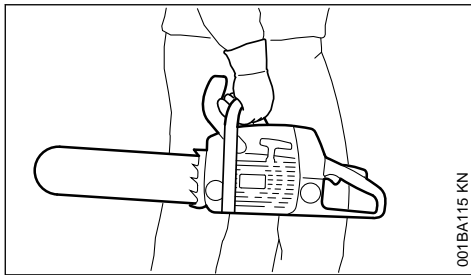

Always carry the chain saw by the handle – with the hot muffler away from your body, the guide bar must point to the rear. To avoid serious burn injuries, avoid touching hot parts of the machine, especially the surface of the muffler.

In vehicles: Properly secure your saw to prevent turnover, fuel spillage and damage.

2.5 Cleaning

Clean plastic parts with a cloth. Harsh detergents can damage the plastic.

Clean the dust and dirt off the machine – do not use any grease solvents for this purpose.

Clean the ventilation slots if necessary.

Do not use a high-pressure cleaner to clean the machine. The hard jet of water can damage parts of the machine.

2.6 Accessories

Only use those tools, guide bars, chains, chain sprockets, accessories or technically equivalent components that have been approved by STIHL for this machine. If you have any questions in this respect, consult a servicing dealer. Use only high quality tools and accessories. Otherwise, there may be a risk of accidents and damage to the machine.

STIHL recommends the use of genuine STIHL tools, guide bars, chains, chain sprockets and accessories. They are specifically designed to match your model and meet your performance requirements.

2.7 Refuelling



Gasoline is an extremely flammable fuel – keep clear of naked flames and fire – do not spill any fuel – no smoking.

Switch off the engine before refuelling.

Never refuel the machine while the engine is still hot – the fuel may spill over – **risk of fire!**

Open the fuel filler cap carefully so that any excess pressure is relieved gradually and fuel does not splash out.

The machine may only be refuelled in a well ventilated place. Clean the machine immediately if fuel is spilled. Do not spill fuel over your clothing – contaminated clothing must be changed immediately.

The machines can be equipped with the following filler caps as standard:

Cliplock filler cap (bayonet-type)



Place the cliplock filler cap (bayonet-type) in position, turn as far as stop and fold the cliplock down.

This helps reduce the risk of unit vibrations causing an incorrectly tightened filler cap to loosen or come off and spill quantities of fuel.



Look out for leaks! Never start the engine if fuel has been spilled or is leaking – **Fatal burns may result!**

2.8 Before Starting Work

Check that your saw is properly assembled and in good condition – refer to appropriate chapters in the instruction manual.

– Check the fuel system for leaks, paying special attention to visible parts such as the tank

cap, hose connections and the manual fuel pump (on machines so equipped). If there are any leaks or damage, do not start the engine – **risk of fire**. Have your saw repaired by a servicing dealer before using it again.

- Check operation of chain brake, front hand guard
- Correctly mounted guide bar
- Correctly tensioned chain
- The trigger and trigger lockout must move freely and spring back to the idle position when they are released.
- Master Control lever must move easily to **STOP, 0** or \odot
- Check that the spark plug boot is secure – a loose boot may cause arcing that could ignite combustible fumes **and cause a fire**.
- Never attempt to modify the controls or safety devices in any way.
- Keep the handles dry and clean – free from oil and dirt – for safe control of the saw.
- Make sure there is sufficient fuel and chain oil in the tanks.

To reduce the risk of personal injury, do not operate your saw if it is damaged or not properly assembled.

2.9 Starting the chain saw

Always work on a level surface. Ensure a firm and secure footing. Hold the machine securely – the chain must not touch any objects or the floor – danger of injury due to the rotating saw chain.

Your chain saw is a one-person saw. Do not allow other persons to be in the working area – not even while starting.

Do not start the chain saw if the chain is in a cut.

Move at least 3 meters away from the place where the machine was refuelled and never start the motor in enclosed spaces.

Lock the chain with the chain brake before starting – **risk of injury** due to rotating chain!

Do not drop-start the engine – start as described in the Instruction Manual.

2.10 During operation

Ensure you always have a firm and safe footing. Take special care when the bark is wet – **danger of slipping!**

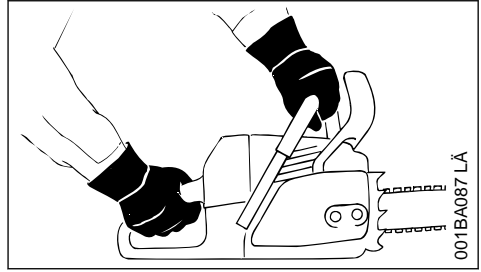

Always hold the chain saw **firmly with both hands**: Right hand on the rear handle – even if you are left-handed. To ensure reliable control, wrap your thumbs tightly around the handlebar and handle.

In the event of impending danger or in an emergency, switch off the engine immediately by moving the Master Control lever / stop switch to **STOP, 0** or \odot .

Never let the machine run unattended.

Exercise caution with slippery surfaces, water, snow, ice, steep slopes, uneven ground or green wood that has just been stripped of its bark – **danger of slipping!**

Use caution with tree stumps, roots, ditches – **danger of stumbling!**

Do not work alone – keep within calling distance of others who are trained in emergency procedures and can provide help in an emergency. Helpers at the cutting site must also wear protective clothing (helmet!) and stand well clear of the branches being cut.

More care and attention than usual are required when wearing ear protection, as warning sounds (shouts, beeps, etc.) cannot be heard properly.

Take a break in good time to avoid tiredness or exhaustion – **risk of accidents!**

Dust (e. g., sawdust), fumes and smoke produced while using the machine may be hazardous to health. If dust is generated, wear a dust mask.

When the engine is running: Note that the saw chain continues to rotate for a short period after you let go of the throttle trigger – coasting effect.

No smoking when working with or near the chain saw - **risk of fire!** Combustible fuel vapour may escape from the fuel system.

Examine the saw chain periodically at short intervals and as soon as you note any tangible changes:

- Switch off the engine; wait until the saw chain is stationary
- Check condition and secure fitting
- Check sharpness

Never touch the saw chain when the engine is running. If the saw chain becomes jammed by an object, switch off the engine immediately before attempting to remove the object – **risk of injury!**

Always turn off the engine before leaving the machine unattended.

To change the saw chain, switch off the engine. **Risk of injury** from the motor starting unintentionally!

Keep easily combustible materials (e. g., wood chips, bark, dry grass, fuel) away from hot exhaust gases and hot mufflers – **risk of fire!** Mufflers with catalytic converters can become especially hot.

Never work without chain lubrication – monitor the oil level in the oil tank. Stop work immediately if the oil level in the oil tank is too low and top up with chain oil – see also "Topping up with chain oil" and "Check chain lubrication".

If the machine is subjected to unusually high loads for which it was not designed (e. g., heavy impact or a fall), always check that it is in good condition before continuing work – see also "Before starting work".

Check the fuel system for leaks and make sure the safety devices are working properly. Never continue using a machine that is not in perfect working order. In case of doubt, have the unit checked by your servicing dealer.

Check for correct idling, so that the saw chain stops moving when the throttle trigger is released. Check the idle setting regularly and correct when possible. Have the machine repaired by a STIHL servicing dealer if the saw chain still continues to move during idling.



The chain saw produces poisonous exhaust gases as soon as the engine starts. These gases may be colourless and odourless and may contain unburnt hydrocarbons and benzene. Never work with the machine indoors or in poorly ventilated areas, even if your machine is equipped with a catalytic converter.

Ensure proper ventilation when working in trenches, hollows or other confined locations – **risk of fatal injury from breathing toxic fumes!**

If you feel sick, have a headache, vision problems (e. g., your field of vision gets smaller), hearing problems, dizziness or inability to concentrate, stop work immediately. Such symptoms may be caused by an excessively high concentration of exhaust emissions – **risk of accident!**

2.11 After finishing work

Switch off the motor, engage the chain brake and attach the chain scabbard.

2.12 Storage

When the machine is not in use, it should be stored in such a way that no-one is endangered. Secure the machine against unauthorised use.

Store the machine in a safe, dry room.

2.13 Vibrations

Prolonged use of the power tool may result in vibration-induced circulation problems in the hands (whitefinger disease).

No general recommendation can be given for the length of usage because it depends on several factors.

The period of usage is prolonged by:

- Hand protection (wearing warm gloves)
- Work breaks

The period of usage is shortened by:

- Any personal tendency to suffer from poor circulation (symptoms: frequently cold fingers, tingling sensations).
- Low outside temperatures.
- The force with which the handles are held (a tight grip restricts circulation).

Continual and regular users should monitor closely the condition of their hands and fingers. If any of the above symptoms appear (e.g. tingling sensation in fingers), seek medical advice.

2.14 Maintenance and repairs

Always switch off the engine before any repair, cleaning or maintenance work and any work on the chain. **Risk of injury** if the engine starts inadvertently!

Exception: adjustment of carburettor and idle speed.

The machine must be serviced regularly. Do not attempt any maintenance or repair work not described in the Instruction Manual. All other work should be carried out by a servicing dealer.

STIHL recommends that maintenance and repair work be carried out only by authorised STIHL dealers. STIHL dealers receive regular training and are supplied with technical information.

Use only high-quality spare parts. Otherwise, there may be a risk of accidents and damage to the machine. If you have any questions in this respect, consult a servicing dealer.

Do not modify the machine in any way – this may increase the risk of personal injury – **risk of accidents!**

To reduce the **risk of fire** due to ignition outside the cylinder, move the master control level to **STOP, 0** or \odot before turning the engine over on the starter when the spark plug boot is removed or the spark plug is unscrewed!

Do not service or store the machine near a naked flame – **risk of fire** due to the fuel.

Check fuel cap regularly for tightness.

Use only spark plugs that are in perfect condition and have been approved by STIHL – see "Specifications".

Check ignition lead (insulation in good condition, secure connection).

Check that the muffler is in perfect working condition.

Do not use the machine if the muffler is damaged or missing – **risk of fire, damage to hearing!**

Never touch a hot muffler – **risk of burns!**

The condition of the anti-vibration elements influences vibration behaviour – inspect anti-vibration elements periodically.

Inspect chain catcher – replace if damaged.

Switch off the engine

- To check the chain tension
- To retension the chain
- To replace the chain
- For remedying malfunctions

Observe sharpening instructions – for safe and proper handling, always keep the chain and guide bar in flawless condition. Keep the chain properly sharpened, tensioned and well lubricated.

Change chain, guide bar and chain sprocket in due time.

Regularly check that the clutch drum is in perfect working condition.

Always store fuel and chain lubricant only in the specified type of containers and ensure they are correctly labelled. Store in a dry, cool and secure place protected against light and sunlight.

In the event of a chain brake malfunction, switch off the machine immediately – **risk of injury!** Consult a servicing dealer – do not use the machine until the malfunction has been remedied, see "Chain brake".

3 Reactive Forces

The most common reactive forces that occur during cutting are: kickback, pushback and pull-in.

3.1 Dangers of kickback



Kickback can result in serious or fatal injury.

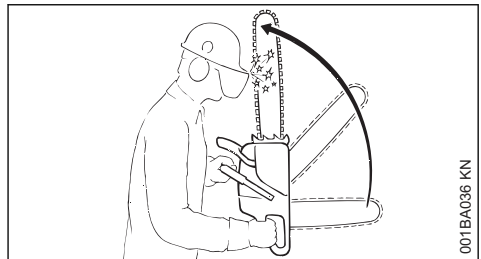

(Kickback) occurs when the saw is suddenly thrown up and back in an uncontrolled arc towards the operator.

3.2 Kickback occurs if, e. g.,

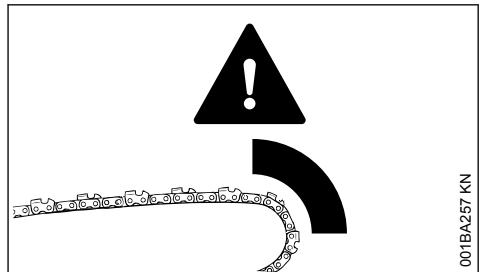

- when the upper quadrant of the bar nose unintentionally contacts wood or another solid

object, e.g. when another limb is touched accidentally during limbing.

- when the chain at the nose of the guide bar is pinched in the cut.

3.3 Quickstop chain brake:

This device reduces the risk of injury in certain situations – it cannot prevent kickback. When activated, the chain brake stops the saw chain within a fraction of a second – see the section "Saw chain" in this Instruction Manual.

3.4 To reduce the risk of kickback

- Work cautiously and avoid situations which could cause kickback.
- Hold the saw firmly with both hands and maintain a secure grip.
- always cut at full throttle.
- Be aware of the location of the guide bar nose at all times.
- do not cut with the bar nose.
- Take special care with small, tough limbs, they may catch the chain.
- never cut several limbs at once.
- do not overreach.
- never cut above shoulder height.
- Use extreme caution when re-entering a previous cut.
- Do not attempt plunge cuts if you are not experienced in this cutting technique.
- be alert for shifting of the log or other forces that may cause the cut to close and pinch the chain.
- always cut with a correctly sharpened, properly tensioned chain – the depth gauge setting must not be too large.
- Use a low kickback chain and a narrow radius guide bar.

3.5 Pull-in (A)

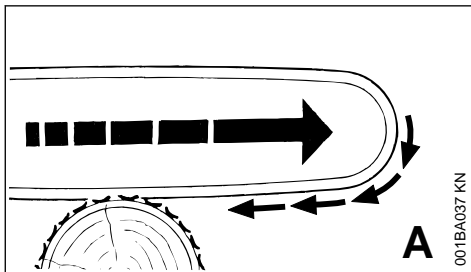

Pull-in occurs when the chain on the bottom of the bar is suddenly pinched, caught or encounters a foreign object in the wood. The reaction of

the chain pulls the saw forward – **to reduce this risk, always engage the spiked bumper securely in the tree or limb.**

3.6 Pushback (B)

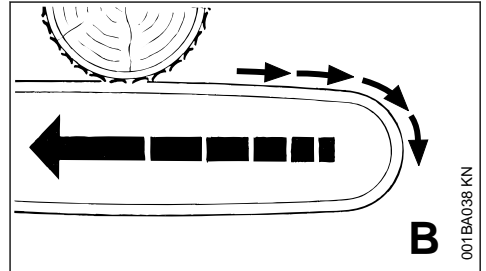

Pushback occurs when the chain on the top of the bar is suddenly pinched, caught or encounters a foreign object in the wood. The reaction of the chain drives the saw straight back toward the operator – **to avoid this risk:**

- Be alert to situations that may cause the top of the guide bar to be pinched
- Do not twist the guide bar in the cut

3.7 Exercise extreme caution

- with leaners
- with trees that have fallen unfavorably between other trees and are under strain
- when working in blowdown areas.

In these cases, do not use a chain saw – use a hoist, winch or drag line instead.

Pull out exposed and cleared logs. Select clear area for cutting.

Deadwood (dry, decayed or rotted wood) represents a considerable risk that is difficult to assess. Identifying the extent of the dangers is complicated, if not impossible. Use aids such as a cable winch or tractor in such cases.

When felling in the vicinity of roads, railways, power lines, etc., take extra precautions. If necessary, inform the police, utility company or railway authority.

4 Working Techniques

Sawing and felling work, including all related work (plunge cutting, limbing, etc.) may only be carried out by persons who have been specially trained and instructed. Persons who are not experienced chain saw users should not carry out any such work – increased risk of accidents!

Country-specific legislation on felling technique must be complied with during felling work.

4.1 Sawing

Do not operate your saw with the starting throttle lock engaged. Engine speed cannot be controlled with the throttle trigger in this position.

Work calmly and carefully – in daylight conditions and only when visibility is good. Ensure you do not endanger others – stay alert at all times.

It is advisable for first-time users to practice cutting logs on a sawbuck – see "Sawing thin wood".

Use the shortest possible guide bar: The chain, guide bar and chain sprocket must match each other and your saw.

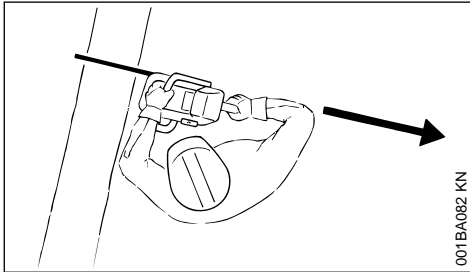

Position the saw so that your body is **clear of the cutting attachment**.

Always pull the saw out of the cut with the chain running.

Use your chain saw for cutting only. It is not designed for prying or shoveling away limbs, roots or other objects.

Do not underbuck freely hanging limbs.

Be careful when cutting scrub and young trees. Thin shoots can be scooped up by the chain saw and hurled towards the user.

Be careful when cutting splintered wood – **Risk of injury from ejected pieces of wood!**

Make sure your saw does not touch any foreign materials: Stones, nails, etc. may be flung off and damage the saw chain. The chain saw may kick back unexpectedly – **risk of accident!**

If a rotating saw chain hits a stone or another hard object, sparks may be generated which may ignite easily flammable materials under certain conditions. Also dried-out plants and brushwood are combustible, above all in hot and dry weather. If there is a risk of fire, do not use the

chain saw in the vicinity of easily combustible materials, dry plants or scrub. It is mandatory that you ask the responsible forestry office about the current fire hazard.



If on a slope, stand on the uphill side of the log. Watch out for rolling logs.

When working at heights:

- Always use a lift bucket
- Never use the machine while standing on a ladder or in a tree
- Never work on an insecure support
- Never work above shoulder height
- Never use the machine with just one hand

Begin cutting with the saw at full throttle and engage the spiked bumper firmly in the wood, and then continue cutting.

Never work without the spiked bumper because the saw may pull you forwards and off balance. Always hold the spiked bumper securely against the tree or limb.

At the end of the cut, the chain saw is no longer supported by the cutting attachment in the cut. The chain saw's weight must be borne by the user – **risk of loss of control!**

Sawing thin wood:

- Use a sturdy and stable support – sawhorse.
- Never hold the log with your leg or foot.
- never allow another person to hold the log or help in any other way.

Limbing

- use a low kickback chain.
- Work with the saw supported wherever possible.
- do not stand on the log while limbing it.
- do not cut with the bar nose.
- watch for limbs which are under tension.
- never cut several limbs at once.

Lying or standing logs under tension:

Always make the cuts in the correct order (first compression side (1), then tension side (2)), oth-

erwise the cutting attachment may stick in the cut or kick back – **risk of injury!**

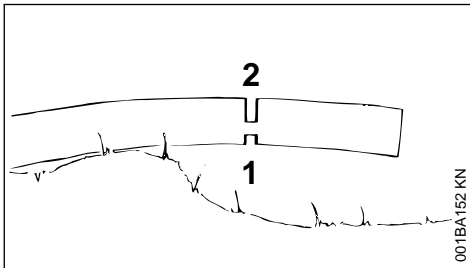
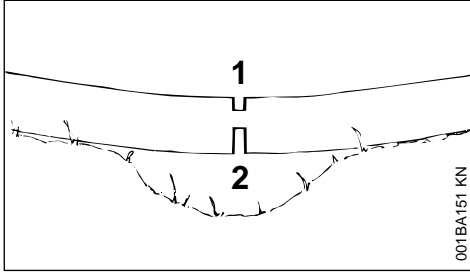

- ▶ Make relieving cut at the compression side (1)
- ▶ Make bucking cut at the tension side (2)

Be wary of **pushback** when making bucking cut from the bottom upwards (underbuck).

NOTICE

Do not cut a lying log at a point where it is touching the ground because the saw chain will otherwise be damaged.

Ripping:

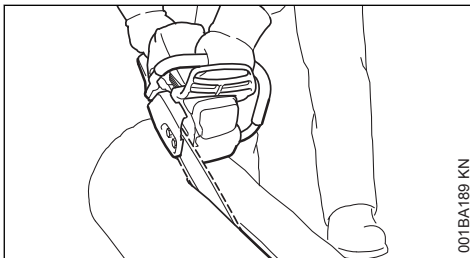

Sawing technique without use of the spiked bumper – risk of pull-in – position the guide bar as shallow an angle as possible – be especially careful – increased **risk of kickback!**

4.2 Preparing for felling

Check that there are no other persons in the felling area – other than helpers.

Make sure no-one is endangered by the falling tree – the noise of your engine may drown any warning calls.

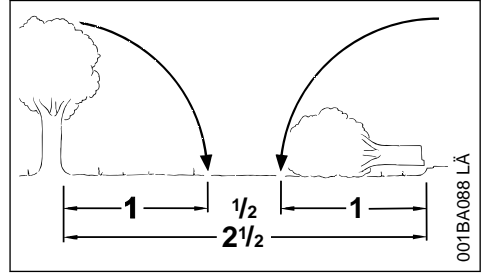

Maintain a distance of at least 2 1/2 tree lengths from the next felling site.

Determining direction of fall and escape path

Select gap in stand into which you want the tree to fall to.

Pay special attention to the following points:

- The natural inclination of the tree
- Unusually heavy limb structure, asymmetrical growth, damage to tree
- The wind direction and speed – do not fell in high winds
- Direction of slope
- Neighboring trees
- Snow load
- Take the general condition of the tree into account – be especially careful with trunk damage or deadwood (brittle, rotten or dead wood)

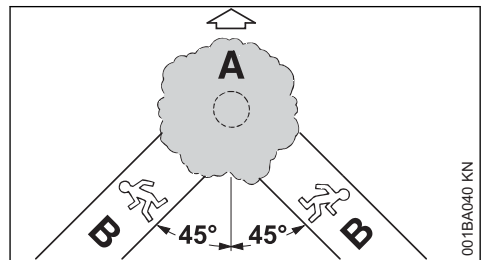

A Direction of fall

B Escape path (escape routes)

- Establish escape paths for each worker – approx. 45° diagonally opposite to the direction of fall

- Clear escape paths, eliminate obstacles
- Put down tools and equipment at a safe distance – but not on the escape paths
- When felling, stand only to the side of the falling trunk and only move back laterally onto the escape path
- Plan escape paths on slopes parallel to the slope
- When walking away along the escape path, watch out for falling limbs and watch the top of the tree.

Preparing work area at base of tree

- First clear the tree base and work area from interfering limbs and brush to provide a secure footing.
- Carefully clear the base of the trunk (e.g., with an axe) – sand, stones and other foreign objects will blunt the saw chain

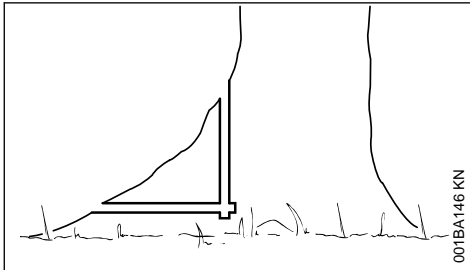

- Remove largest buttresses: first the largest buttress – saw first vertically, then horizontally – only if the tree is in sound condition

4.3 Felling notch

Preparing the felling notch

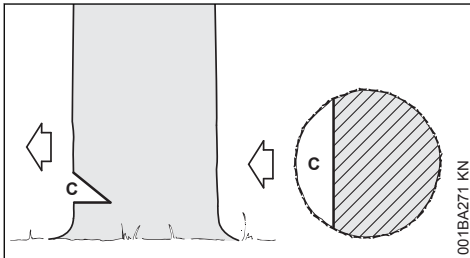

The felling notch (C) determines the direction of fall.

Important:

- Make a felling notch at right angle to direction of fall
- Saw as close to the ground as possible
- Cut to a depth of approx. 1/5 to 1/3 of the diameter of the trunk

Determine direction of fall with gunning sight on cover and fan housing

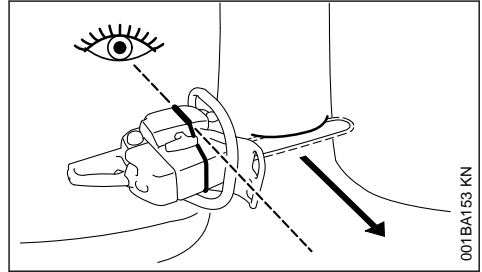

Your chainsaw has a gunning sight on the cover and fan housing. Use this gunning sight.

Making the felling notch

When making a felling notch, align the chainsaw so that the notch lies at a right angle to the direction of fall.

During the procedure, various sequences are permitted for making a felling notch with a bottom (horizontal) cut and top (angled) cut – comply with national legislation regarding felling technique.

- ▶ Make a bottom (horizontal) cut
- ▶ Make the top (angled) cut approx. 45°- 60° to the bottom cut

Checking the direction of fall

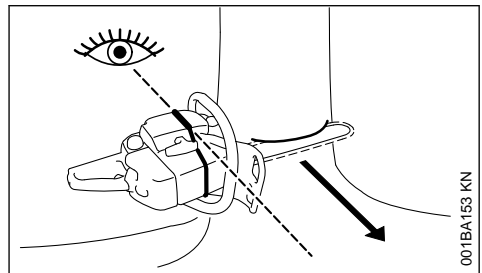

- ▶ Insert the chainsaw with guide bar in the bottom of the felling notch. The gunning sight must point in the planned direction of fall – if necessary, correct direction of fall by re-cutting the felling notch.

4.4 Sapwood cuts

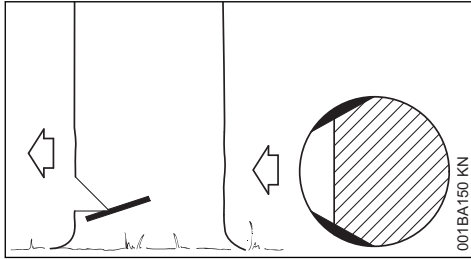

Sapwood cuts in long-fibered softwood help prevent sapwood splintering when the tree falls. Make cuts at both sides of the trunk at same height as bottom of felling notch to a depth of about 1/10 of trunk diameter. On large diameter trees, cut to no more than width of guide bar.

Do not make sapwood cuts if wood is diseased.

4.5 Basic information on felling cut

Basic dimensions

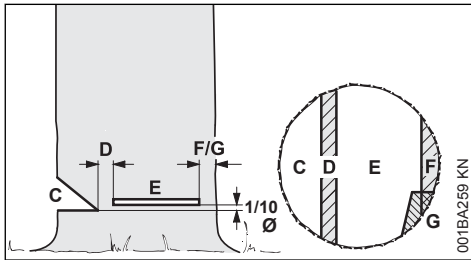

The **felling notch** (C) determines the direction of fall.

The **hinge** (D) functions like a real hinge to guide the tree to the ground.

- Width of hinge: approx. 1/10 of the trunk diameter
- Never saw through the hinge while felling – otherwise the tree will fall in a direction other than the one planned – **risk of accident!**
- With rotten trunks, leave a wider hinge

The tree is felled with the **felling cut** (E).

- Cut horizontally
- 1/10 (at least 3 cm) of tree diameter higher than bottom of felling notch (C).

The **holding strap** (F) or **stabilizing strap** (G) supports the tree and helps prevent it from falling prematurely.

- Width of strip: approx. 1/10 to 1/5 of the trunk diameter
- Do not cut into the strip during the felling cut

- With rotten trunks, leave a wider strip

Plunge cutting

- For relieving cuts during shortening
- For wood carving

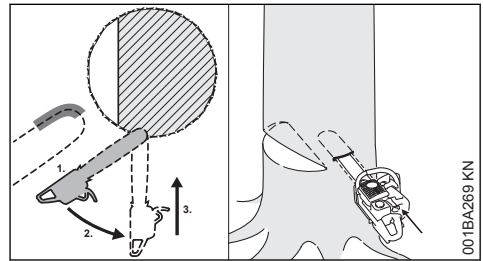

▶ Use a low kickback saw chain and proceed with special care

1. Begin cut by applying the lower portion of the guide bar nose – do not use upper portion because of **risk of kickback**. Cut at full strength until the depth of the kerf is twice the width of the guide bar
2. Swing the machine slowly into the plunge cutting position – **risk of kickback and pushback!**
3. Make the plunge cut very carefully. **Risk of pushback.**

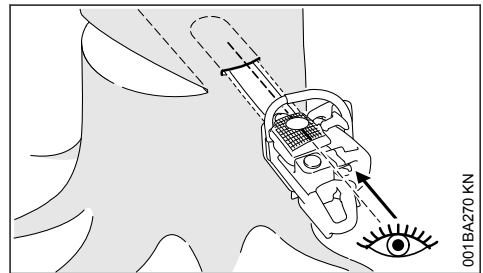

Where possible, use a plunge blade. The plunge blade and the upper/lower side of the guide bar are parallel.

During plunge cutting, the plunge bar helps to keep the hinge parallel in form, i.e. the same thickness at all points. To do this, guide the plunge bar parallel to the sink chord.

Felling wedges

Insert the felling wedge as soon as possible, i.e. as soon as no obstruction of saw control is to be expected. Position the felling wedge in the felling cut and drive in with suitable tools.

Only use aluminum or plastic wedges – do not use steel wedges. Steel wedges can seriously

damage the saw chain and cause dangerous kickback.

Select suitable felling wedges dependent on the trunk diameter and the width of the kerf (analogue to felling cut (E)).

Contact the STIHL dealer for the selection of the felling wedge (suitable length, width and height).

4.6 Selecting the appropriate felling cut

The selection of the appropriate felling cut is dependent on the same tree characteristics that must be noted when determining the direction of fall and the escape paths.

There are various different features of these characteristics. This User Manual will only describe the two most commonly occurring variants:

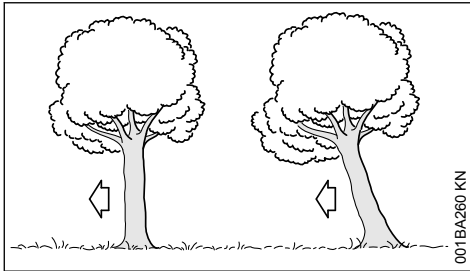

left:	Normal tree – vertically upright tree with uniform crown
right:	Leaner tree - crown pointing in direction of fall

4.7 Felling cut with stabilizing strap (normal tree)

A) Thin trunks

Implement this felling cut when the trunk diameter is smaller than the cutting length of the chainsaw.

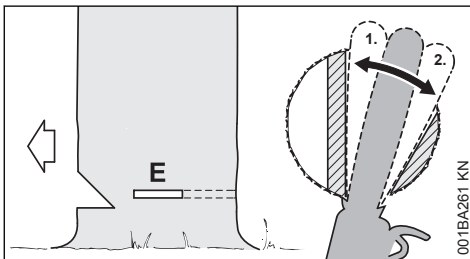

Shout a warning before starting the felling cut.

- ▶ Plunge cut the felling cut (E) – plunge the guide bar fully in
- ▶ Engage the spiked bumper behind the hinge and use this as the rotation point – reposition the chainsaw as little as possible
- ▶ Make the felling cut up to the hinge (1)
 - Do not cut into the hinge
- ▶ Make the felling cut up to the stabilizing strap (2)
 - Do not cut into the stabilizing strap

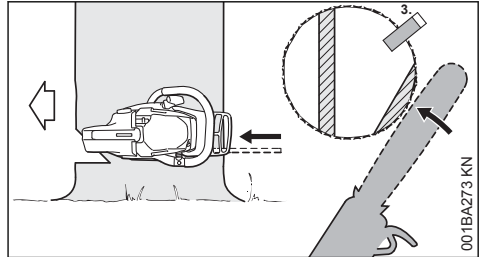

- ▶ Set the felling wedge (3)

Shout a second warning immediately before the tree falls.

- ▶ Cut through the stabilizing strap, horizontal level with the felling cut, with arms fully extended

B) Thick trunks

Implement this felling cut when the trunk diameter is greater than the cutting length of the machine.

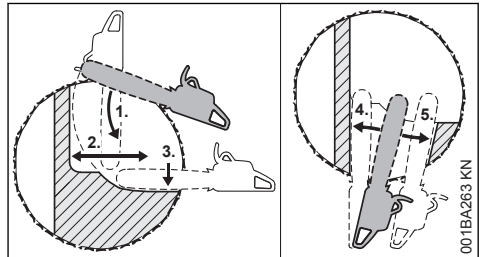

Shout a warning before starting the felling cut.

- ▶ Engage the spiked bumper at the height of the felling cut and use this as the rotation point – reposition the chainsaw as little as possible
- ▶ Tip of the guide bar must penetrate the wood before the hinge (1) – guide the chainsaw absolutely horizontally and swivel as widely as possible
- ▶ Make the felling cut up to the hinge (2)
 - Do not cut into the hinge

- ▶ Make the felling cut up to the stabilizing strap (3)
 - Do not cut into the stabilizing strap

The felling cut must be continued on the opposite side of the trunk.

Ensure that the second cut is at the same level as the first cut.

- ▶ Plunge cut the felling cut
- ▶ Make the felling cut up to the hinge (4)
 - Do not cut into the hinge
- ▶ Make the felling cut up to the stabilizing strap (5)
 - Do not cut into the stabilizing strap

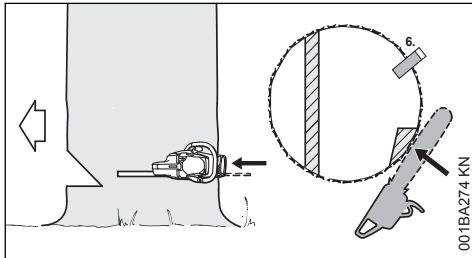

- ▶ Set the felling wedge (6)

Shout a second warning immediately before the tree falls.

- ▶ Cut through the stabilizing strap, horizontal level with the felling cut, with arms fully extended

4.8 Felling Cut with Holding Strap (Leaner)

A) Thin trunks

Implement this felling cut when the trunk diameter is smaller than the cutting length of the chainsaw.

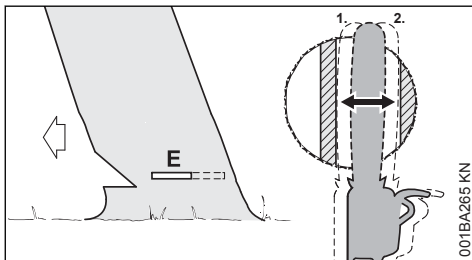

- ▶ Plunge cut the guide bar into the trunk until it exits on the other side
- ▶ Make the felling cut (E) towards the hinge (1)
 - Cut horizontally
 - Do not cut into the hinge

- ▶ Make the felling cut towards the holding strap (2)
 - Cut horizontally
 - Do not cut into the holding strap.

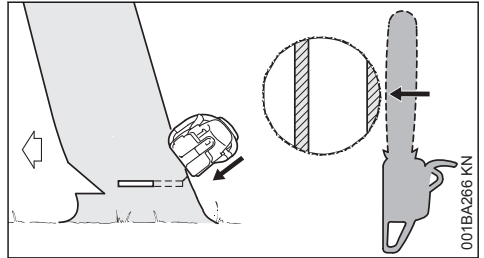

Shout a second warning immediately before the tree falls.

- ▶ With outstretched arms, cut through the holding strap at a downward angle from outside.

B) Thick trunks

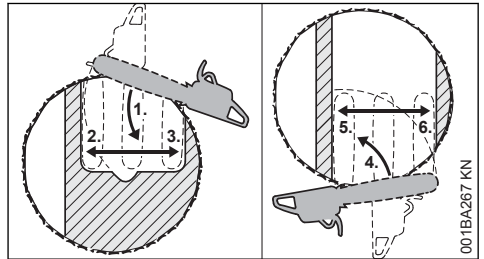

Perform this felling cut when the tree diameter is greater than the cutting length of the chainsaw.

- ▶ Engage the spiked bumper behind the holding strap and use it as a pivot – avoid repositioning the chainsaw more than necessary.
- ▶ The guide bar nose enters the wood (1) before it reaches the hinge – hold the chainsaw horizontally and swing it as far as possible.
 - Do not cut into the holding strap or hinge.
- ▶ Make the felling cut up to the hinge (2)
 - Do not cut into the hinge
- ▶ Make the felling cut up to the holding strap (3)
 - Do not cut into the holding strap.

The felling cut must be continued on the opposite side of the trunk.

Ensure that the second cut is at the same level as the first cut.

- ▶ Engage the spiked bumper behind the hinge and use this as the rotation point – reposition the chainsaw as little as possible

- ▶ Tip of the guide bar must penetrate the wood before the holding strap (4) – guide the chainsaw absolutely horizontally and swivel as widely as possible
- ▶ Make the felling cut up to the hinge (5)
 - Do not cut into the hinge
- ▶ Make the felling cut up to the holding strap (6)
 - Do not cut into the holding strap.

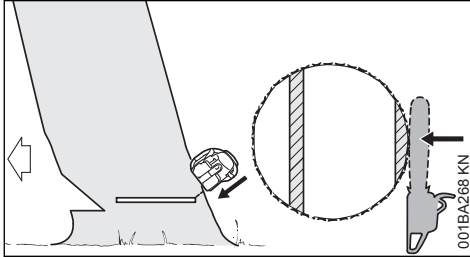

Shout a second warning immediately before the tree falls.

- ▶ With outstretched arms, cut through the holding ring at a downward angle from outside.

5 Cutting Attachment

A cutting attachment consists of the saw chain, guide bar and chain sprocket.

The cutting attachment that comes standard is designed to exactly match the chain saw.

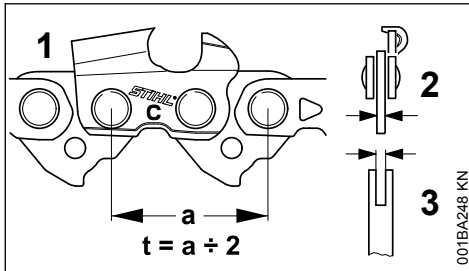

- The pitch (t) of the saw chain (1), chain sprocket and the nose sprocket of the Rollo-matic guide bar must match.
- The drive link gauge (2) of the saw chain (1) must match the groove width of the guide bar (3).

If non-matching components are used, the cutting attachment may be damaged beyond repair after a short period of operation.

5.1 Chain Scabbard

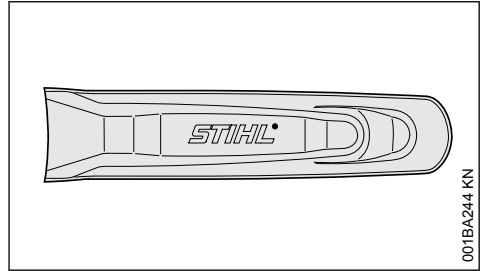

Your saw comes standard with a chain scabbard that matches the cutting attachment.

If guide bars of different lengths are mounted to the saw, always use a chain scabbard of the correct length which covers the complete guide bar.

The length of the matching guide bars is marked on the side of the chain scabbard.

6 Mounting the Bar and Chain (side chain tensioner)

6.1 Removing the chain sprocket cover

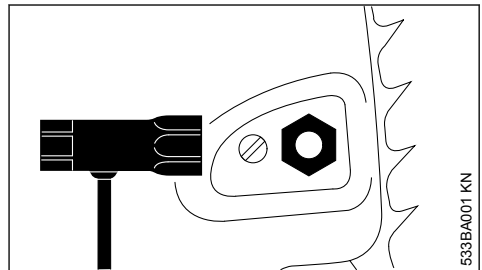

- ▶ Unscrew the nut and remove the chain sprocket cover.

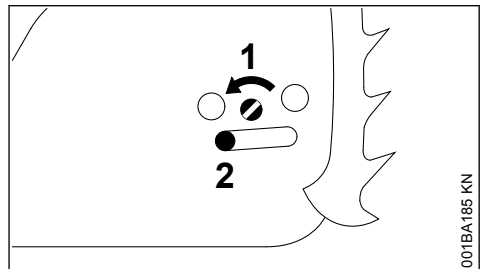

- ▶ Turn the screw (1) counterclockwise until the tensioner slide (2) butts against the left end of the housing slot.

6.2 Disengage the chain brake.

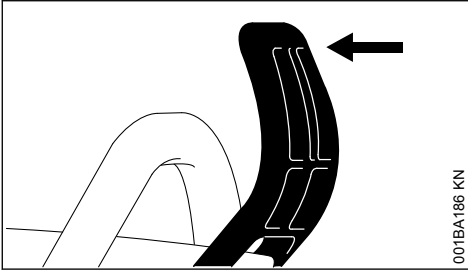

001BA186 KN

- ▶ Pull the hand guard towards the front handle until there is an audible click – the chain brake is disengaged.

6.3 Fitting the chain

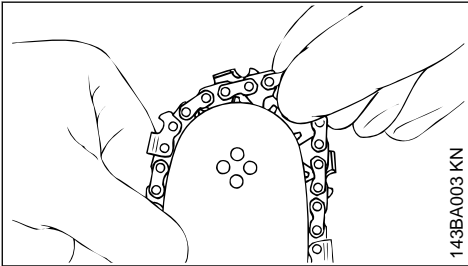

143BA003 KN

! WARNING

Wear work gloves to protect your hands from the sharp cutters.

- ▶ Fit the chain – start at the bar nose.

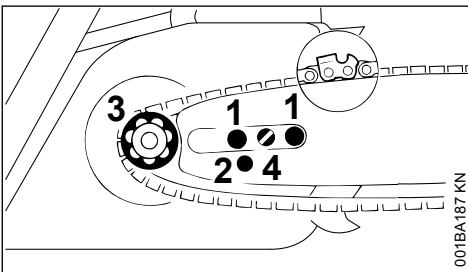

001BA187 KN

- ▶ Fit the guide bar over the studs (1) – the cutting edges on the top of the bar must point to the right.
- ▶ Engage the peg of the tensioner slide in the locating hole (2) – place the chain over the sprocket (3) at the same time.

- ▶ Turn the tensioning screw (4) clockwise until there is very little chain sag on the underside of the bar – and the drive link tangs are engaged in the bar groove.
- ▶ Refit the sprocket cover and screw on the nut only fingertight.
- ▶ Go to chapter on "Tensioning the Saw Chain"

7 Mounting the Bar and Chain (quick chain tensioner)

7.1 Removing the chain sprocket cover

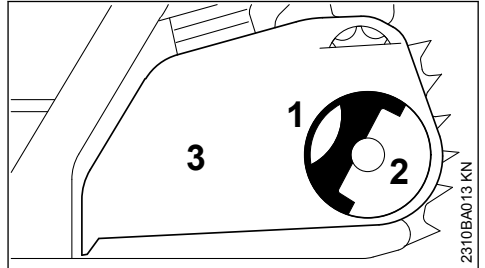

2310BA013 KN

- ▶ Swing grip (1) into position (until it engages)
- ▶ Turn the wing nut (2) to the left until it hangs loosely in the chain sprocket cover (3)
- ▶ Remove chain sprocket cover (3)

7.2 Mounting the tensioning gear

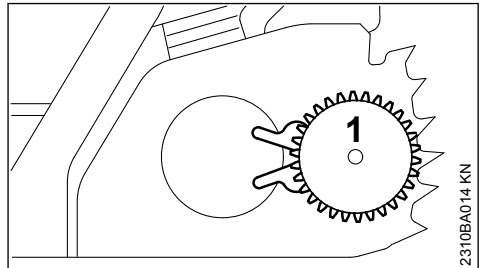

2310BA014 KN

- ▶ Remove and reverse tensioning gear (1)

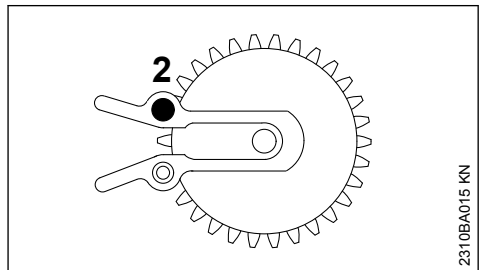

2310BA015 KN

- ▶ Remove screw (2)

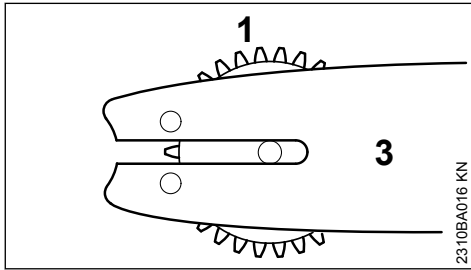

- ▶ Position tensioning gear (1) and guide bar (3) relative to one another

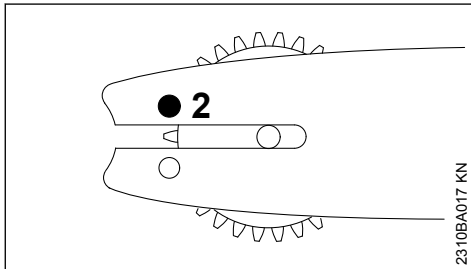

- ▶ Insert and tighten screw (2)

7.3 Releasing the chain brake

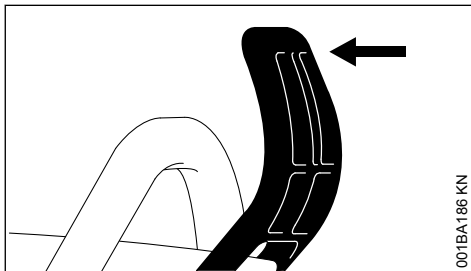

- ▶ Pull hand guard towards the front handle until it engages audibly – chain brake is released

7.4 Fitting the saw chain

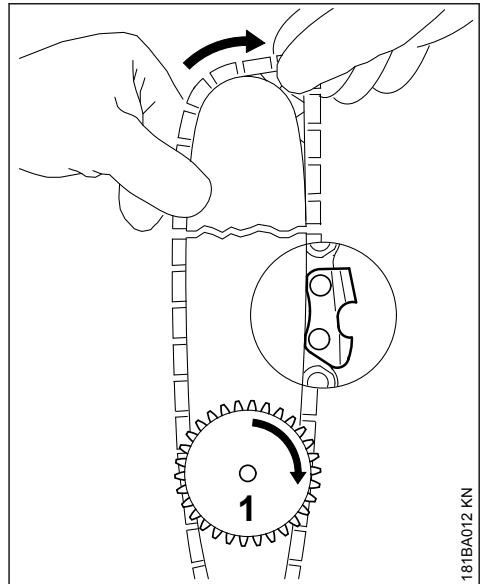

! WARNING

Put on protective gloves – risk of injury by the sharp cutters.

- ▶ Fit the saw chain – starting at the nose of the guide bar – pay attention to the position of the tensioning gear and the cutting edges
- ▶ Turn tensioning gear (1) to the right as far as possible
- ▶ Turn the guide bar so that the tensioning gear faces the user

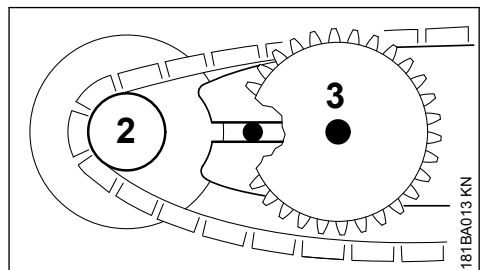

- ▶ Place the saw chain on the chain sprocket (2)
- ▶ Slide the guide bar over the collar screw (3); the head of the rear collar screw must protrude into the oblong hole

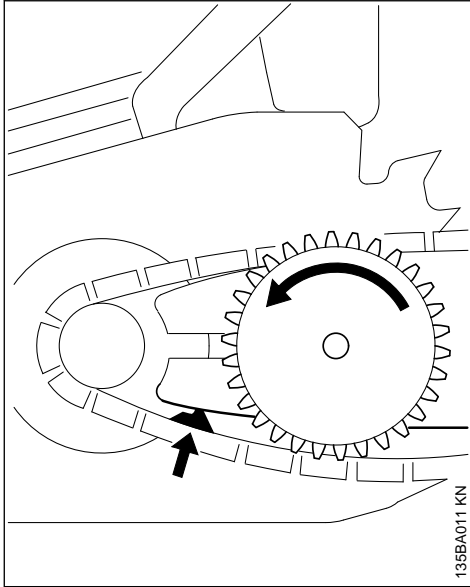

- ▶ Guide the drive link into the bar groove (see arrow) and turn the tensioning gear to the left as far as possible
- ▶ Fit chain sprocket cover, sliding the guide lugs into the engine housing openings

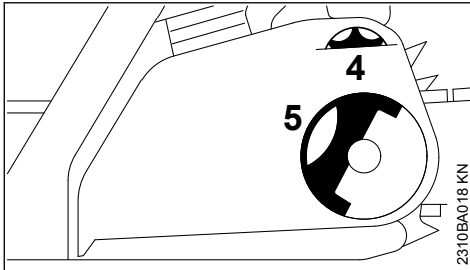

When fitting the chain sprocket cover, the teeth of the adjusting wheel and the tensioning gear must mesh; if necessary,

- ▶ turn the adjusting wheel (4) a little until the chain sprocket cover can be slid completely against the engine housing
- ▶ Swing grip (5) into position (until it engages)
- ▶ Fit wing nut and tighten lightly
- ▶ Next step: see "Tensioning the Saw Chain"

8 Tensioning the Saw Chain (side chain tensioner)

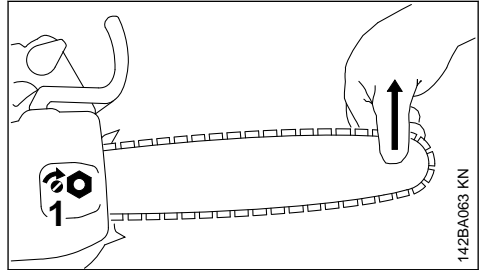

Retensioning during cutting work:

- ▶ Switch off the engine.
- ▶ Loosen the nut.
- ▶ Hold the bar nose up.
- ▶ Use a screwdriver to turn the tensioning screw (1) clockwise until the chain fits snugly against the underside of the bar.
- ▶ While still holding the bar nose up, tighten down the nut firmly.
- ▶ Go to "Checking Chain Tension".

A new chain has to be retensioned more often than one that has been in use for some time.

- ▶ Check chain tension frequently – see chapter on "Operating Instructions".

9 Tensioning the Saw Chain (quick chain tensioner)

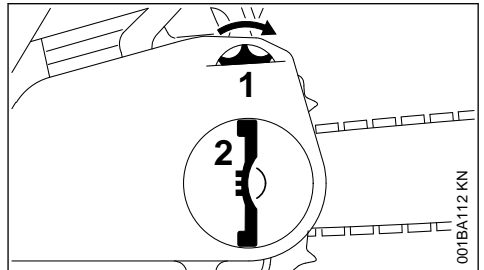

Retensioning during cutting work:

- ▶ Shut off the engine.
- ▶ Pull out the hinged clip and loosen the wingnut.
- ▶ Turn the adjusting wheel (1) clockwise as far as stop.
- ▶ Tighten down the wingnut (2) firmly by hand.
- ▶ Fold down the hinged clip.
- ▶ Go to "Checking Chain Tension"

A new chain has to be retensioned more often than one that has been in use for some time.

- ▶ Check chain tension frequently – see chapter on "Operating Instructions".

10 Checking Chain Tension

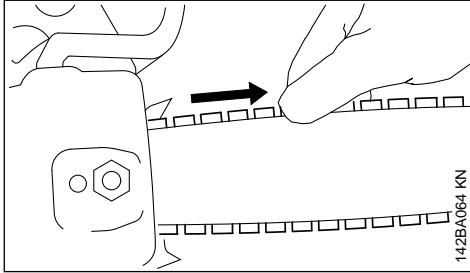

- ▶ Shut off the engine.
- ▶ Wear work gloves to protect your hands.
- ▶ The chain must fit snugly against the underside of the bar and it must still be possible to pull the chain along the bar by hand when the chain brake is released.
- ▶ If necessary, retension the chain.

A new chain has to be retensioned more often than one that has been in use for some time.

- ▶ Check chain tension frequently – see chapter on "Operating Instructions".

11 Fuel

The engine requires a mixture of gasoline and engine oil.



WARNING

Avoid direct skin contact with fuel and breathing in of gasoline fumes.

11.1 STIHL MotoMix

STIHL recommends using STIHL MotoMix. This pre-blended fuel is free of benzene and lead, is distinguished by a high octane rating, and always provides the proper mixing ratio.

STIHL MotoMix uses STIHL HP Ultra two-stroke engine oil for optimum engine life.

MotoMix is not available in all markets.

11.2 Mixing fuel

NOTICE

Unsuitable fuels or a mixing ratio that deviates from the specification can lead to severe engine damage. The engine, seals, fuel lines and fuel tank may be damaged if low-quality gasoline or engine oil is used.

11.2.1 Gasoline

Use only **high-quality gasoline** with an octane rating of at least 90 ROC – leaded or unleaded.

Gasoline with an alcohol component exceeding 10% can cause impaired engine performance in engines with manually adjustable carburetors and thus should not be used in these engines.

Engines with M-Tronic deliver full engine performance using gasoline with an alcohol component of up to 27% (E27).

11.2.2 Engine oil

If you mix the fuel yourself, use only STIHL two-stroke engine oil or another high-performance engine oil classified as JASO FB, JASO FC, JASO FD, ISO-L-EGB, ISO-L-EGC or ISO-L-EGD.

STIHL specifies STIHL HP Ultra two-stroke engine oil or an equivalent high-performance engine oil in order to maintain emission limits over the machine's service life.

11.2.3 Mixing ratio

with STIHL two-stroke engine oil 1:50; 1:50 = 1 part oil + 50 parts gasoline

11.2.4 Examples

Quantity of gasoline	STIHL two-stroke engine oil 1:50	
Liters	Liters	(ml)
1	0.02	(20)
5	0.10	(100)
10	0.20	(200)
15	0.30	(300)
20	0.40	(400)
25	0.50	(500)

- ▶ Pour oil into an approved safety fuel canister first, then add gasoline and mix thoroughly

11.3 Storing fuel mixture

Store in approved safety fuel canisters only in a dry, cool and secure place protected against light and sunlight.

Fuel mixture deteriorates with age – mix only as much as needed for a few weeks. Do not store fuel mixture for longer than 30 days. The fuel mixture can become unusable more quickly if exposed to light, sunlight or low or high temperatures.

STIHL MotoMix however can be stored for up to 5 years without any problems.

- ▶ Shake the canister containing the fuel mixture thoroughly before refueling

WARNING

Pressure may have built up in the canister – open it carefully.

- ▶ The fuel tank and the canister in which fuel mixture is stored should be cleaned thoroughly from time to time

Residual fuel and the liquid used for cleaning must be disposed of in accordance with regulations and without harming the environment!

12 Fueling



12.1 Preparing the machine

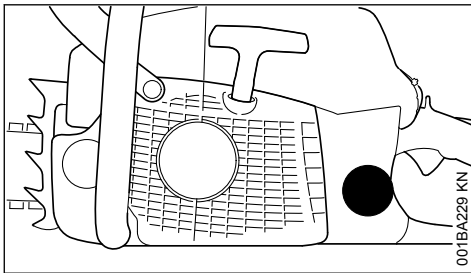

- ▶ Before fueling, clean the cap and the area around it to ensure that no dirt falls into the fuel tank
- ▶ Always position the machine so that the cap is facing upwards

12.2 Different markings on filler caps

Filler caps and fuel tanks can be marked differently.

Depending on the version, filler cap and fuel tank may be available with or without markings.

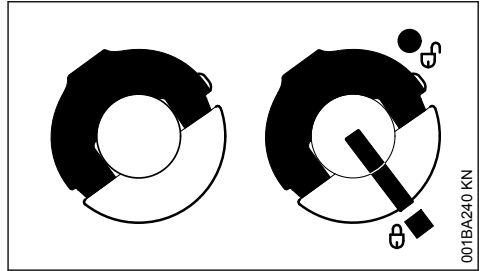

left:	Filler cap - without markings
right:	Filler cap - with markings on cap and fuel tank

12.3 Filler cap without marking

12.3.1 To open:

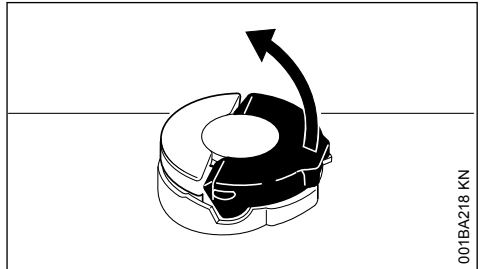

- ▶ Open bracket until it is vertical

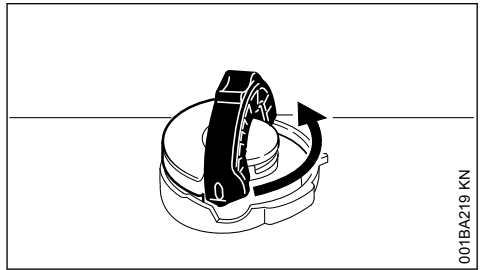

- ▶ Turn the filler cap counterclockwise (approx. 1/4 turn)

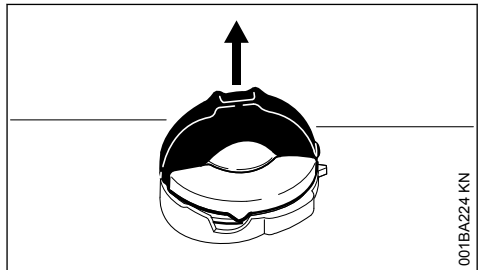

- ▶ Remove the filler cap

12.3.2 Filling with fuel

Take care not to spill fuel while fueling and do not overfill the tank.

STIHL recommends using the STIHL filling system for fuel (special accessory).

- ▶ Fill with fuel

12.3.3 Closing

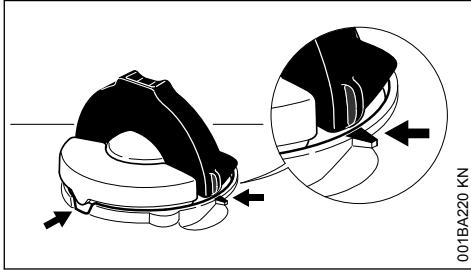

Bracket is in an upright position:

- ▶ Position filler cap – position markings on the filler cap and the filler port must be aligned with each other.
- ▶ Push the filler cap down as far as it will go

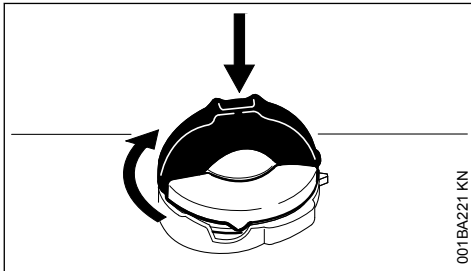

- ▶ Hold the filler cap down and turn it clockwise until it engages

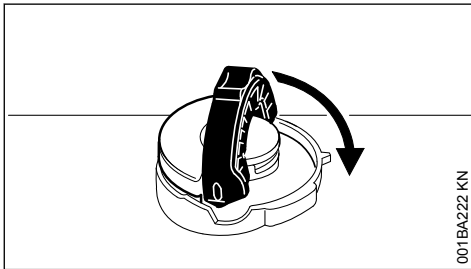

- ▶ Fold down the bracket as far as it will go

12.3.4 Checking the lock

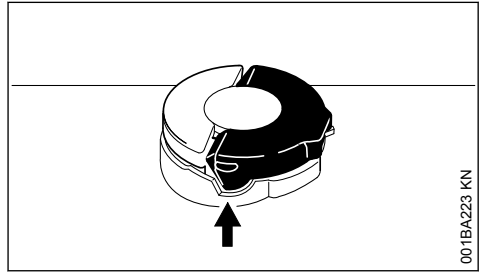

- The lug on the bracket must engage entirely in the recess (arrow)

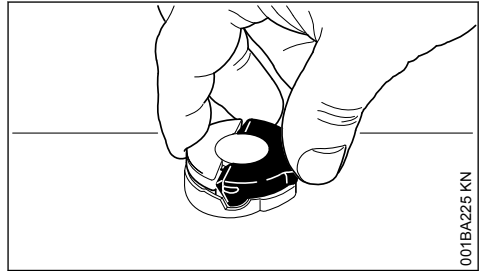

- ▶ Grip the filler cap – if the filler cap cannot be moved or removed, then it is closed properly

12.3.5 If the filler cap can be moved or removed

The base of the filler cap is twisted in relation to the upper part.

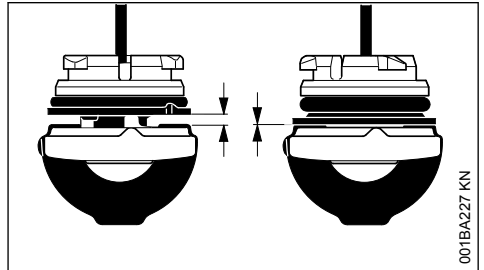

- | | |
|--------|---|
| left: | Base of filler cap twisted |
| right: | Base of filler cap correctly positioned |

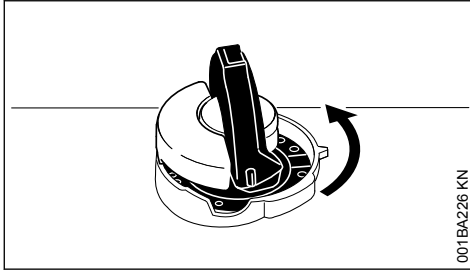

001BA226 KN

- ▶ Fit filler cap and turn it counterclockwise until it engages in the seat of the filling port
- ▶ Continue to turn the filler cap counterclockwise (approx. 1/4 turn) – this will twist the base of the cap into the correct position
- ▶ Turn the filler cap clockwise and close it – see the section "Closing" and "Checking the lock"

12.4 Filler cap with marking

12.4.1 To open:

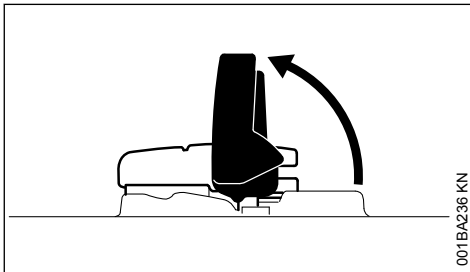

001BA236 KN

- ▶ Open bracket

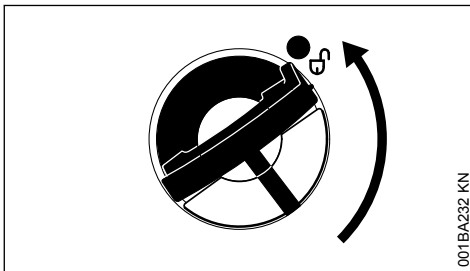

001BA232 KN

- ▶ Turn filler cap (approx. 1/4 turn)

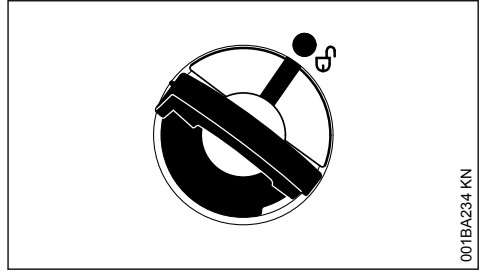

001BA234 KN

Markings on filler cap and fuel tank must align

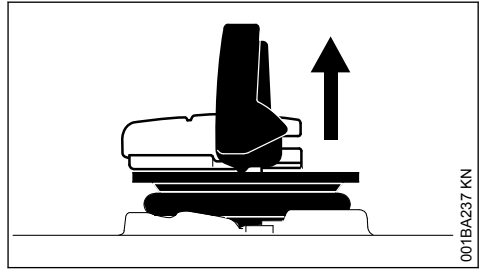

001BA237 KN

- ▶ Remove the filler cap

12.4.2 Filling with fuel

Take care not to spill fuel while fueling and do not overfill the tank.

STIHL recommends using the STIHL filling system for fuel (special accessory).

- ▶ Fill with fuel

12.4.3 Closing

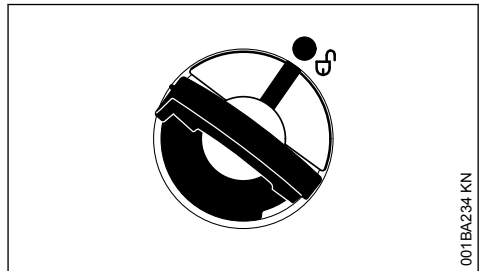

001BA234 KN

Bracket is in an upright position:

- ▶ Position filler cap – markings on filler cap and fuel tank must align
- ▶ Push the filler cap down as far as it will go

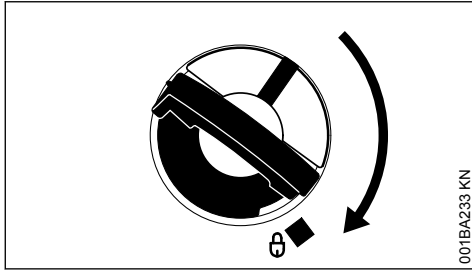

001BA233 KN

- ▶ Hold the filler cap down and turn it clockwise until it engages

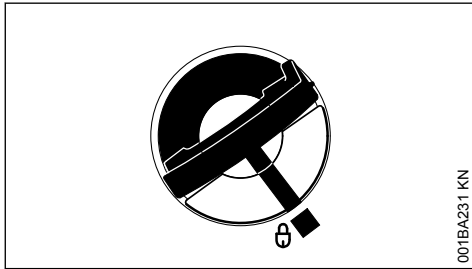

001BA231 KN

Then the markings on filler cap and fuel tank will align

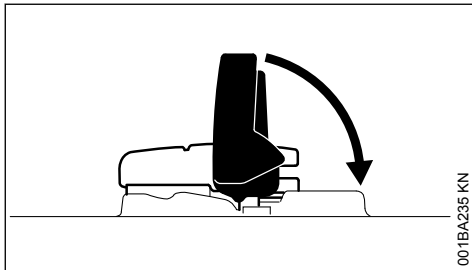

001BA235 KN

- ▶ Close bracket lock

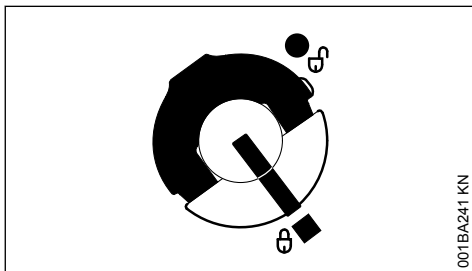

001BA241 KN

Filler cap is locked

12.4.4 If the filler cap will not lock onto the fuel tank

The base of the filler cap is twisted in relation to the upper part.

- ▶ Remove the filler cap from the fuel tank and look at it from above

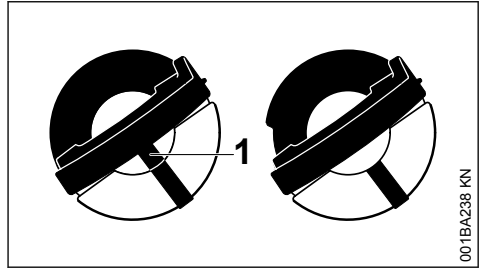

001BA238 KN

left:	Base of filler cap is twisted – interior marking (1) is aligned with the exterior marking
right:	Base of filler cap is in the correct position – interior marking is below the bracket. It does not align with the exterior marking

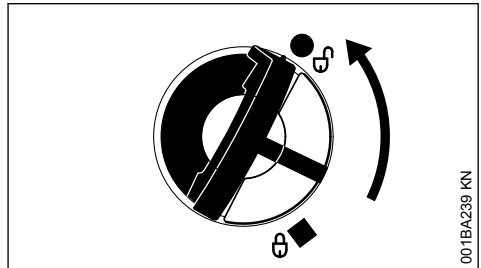

001BA239 KN

- ▶ Fit filler cap and turn it counterclockwise until it engages in the seat of the filling port
- ▶ Continue to turn the filler cap counterclockwise (approx. 1/4 turn) – this will twist the base of the cap into the correct position
- ▶ Turn the filler cap clockwise and close it – see section "Closing"

13 Chain Lubricant

For automatic and reliable lubrication of the chain and guide bar – use only an environmentally compatible quality chain and bar lubricant. Rapidly biodegradable STIHL BioPlus is recommended.

NOTICE

Biological chain oil must be resistant to aging (e.g. STIHL BioPlus), since it will otherwise quickly turn to resin. This results in hard deposits that are difficult to remove, especially in the area of the chain drive and chain. It may even cause the oil pump to seize.

The service life of the chain and guide bar depends on the quality of the lubricant. It is therefore essential to use only a specially formulated chain lubricant.

! WARNING

Do not use waste oil. Renewed contact with waste oil can cause skin cancer. Moreover, waste oil is environmentally harmful.

NOTICE

Waste oil does not have the necessary lubricating properties and is unsuitable for chain lubrication.

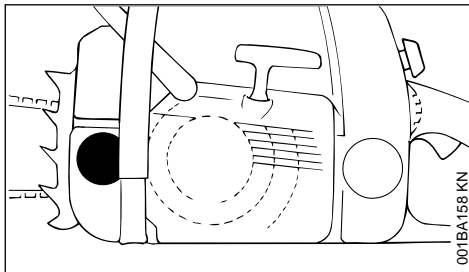
14 Filling Chain Oil Tank**14.1 Preparations**

- ▶ Thoroughly clean the oil filler cap and the area around it to ensure that no dirt falls into the tank.
- ▶ Position the machine so that the filler cap is facing up.
- ▶ Open the filler cap.

14.2 Fill up with chain oil.

- ▶ Refill the chain oil tank every time you refuel.

Take care not to spill chain oil while refilling and do not overfill the tank.

STIHL recommends you use the STIHL filler nozzle for chain oil (special accessory).

- ▶ Close the filler cap.

There must still be a small amount of oil in the oil tank when the fuel tank is empty.

If the oil level in the tank does not go down, the reason may be a fault in the oil supply system: Check chain lubrication, clean the oilways, contact your dealer for assistance if necessary. STIHL recommends that you have servicing and repair work carried out exclusively by an authorized STIHL servicing dealer.

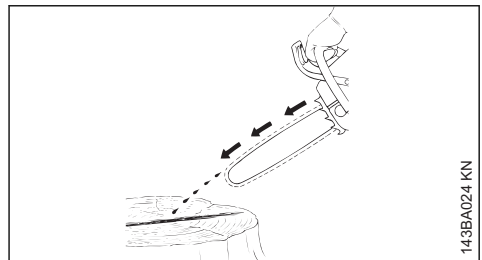
15 Checking Chain Lubrication

The saw chain must always spin off a small amount of oil.

NOTICE

Never operate your machine without chain lubrication. If the saw chain runs dry, the cutting attachment may very quickly be damaged beyond repair. Before starting work, always check the chain lubrication and oil level in the tank.

Every new saw chain needs a run-in time of 2 to 3 minutes.

After the saw chain has run in, check the tension of the chain and correct if necessary – see "Checking the chain tension".

16 Chain Brake

16.1 Saw chain, lock

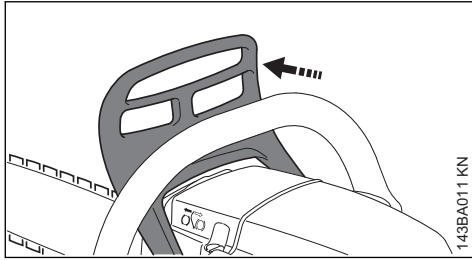

- in an emergency
- when starting
- when idling

Press the hand guard towards the nose of the guide bar with the left hand - or automatically due to kickback: Saw chain is blocked - and stops running.

16.2 Disengage the chain brake.

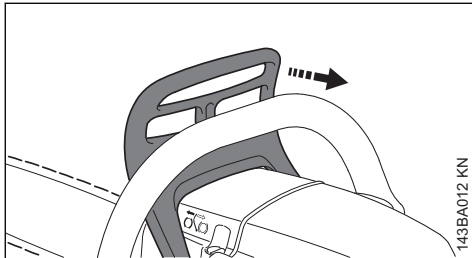

- ▶ Pull the hand guard back towards the front handle.

NOTICE

The chain brake must be released before opening the throttle (except during functional check-out) and before sawing.

Running the engine at high revs with the chain brake engaged (chain locked) will quickly damage the engine and chain drive (clutch, chain brake).

The chain brake is also activated by the inertia of the front hand guard if the kickback force of the saw is high enough: The hand guard is accelerated toward the bar nose – even if your left hand is not behind the hand guard, e.g. during felling cut.

The chain brake will operate only if the hand guard has not been modified in any way.

16.3 Checking Operation of the Chain Brake

Before starting work: Run engine at idle speed, engage the chain brake (push hand guard towards bar nose) and open the throttle wide for (no more than 3 seconds) – the chain must not rotate. The hand guard must be free of dirt and easily moveable.

16.4 Chain Brake Maintenance

The chain brake is subject to (normal wear). It is necessary to have it serviced and maintained regularly by trained personnel. STIHL recommends that maintenance and repair work be carried out only by authorised STIHL dealers. The following intervals must be complied with:

Full-time use:	quarterly
Part-time use:	every six months
occasional use:	annually

17 Winter Operation



17.1 Winter slide (MS 211 only)

At temperatures below +10 °C:

- ▶ Remove the shroud – see "Shroud"

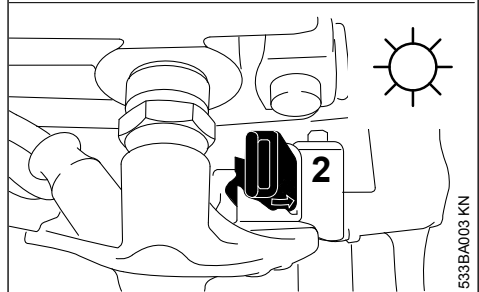
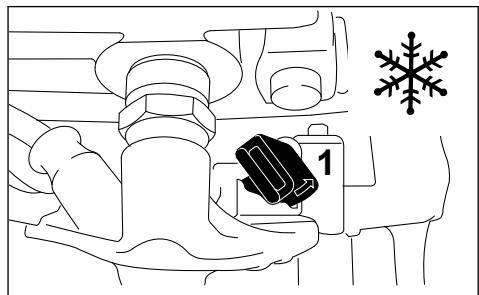

- ▶ Use the combination wrench to turn the slide next to the spark plug by 45° counterclockwise

- 1 winter operation
- 2 summer operation

► Fit the shroud – see "Shroud"

Heated air is now drawn in from around the cylinder and circulates around the carburetor – this helps prevent carburetor icing.

NOTICE

At temperatures above + 20 °C, always return the slide to the position for summer operation!
Risk of engine malfunction – overheating!

17.2 Attach cover plate

(Special accessory, not for ErgoStart versions)

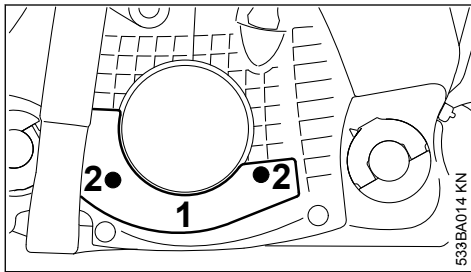

- Fit cover plate (1) and fasten with screws (2)
- if the chain saw is extremely cold, after starting, bring the engine up to operating temperature

MS 211 only: When using the cover plate, the winter slide can be set to winter operation or summer operation. At temperatures below +10°C, set the slide to the position for winter operation.

18 Starting / Stopping the Engine

18.1 Positions of the master control lever

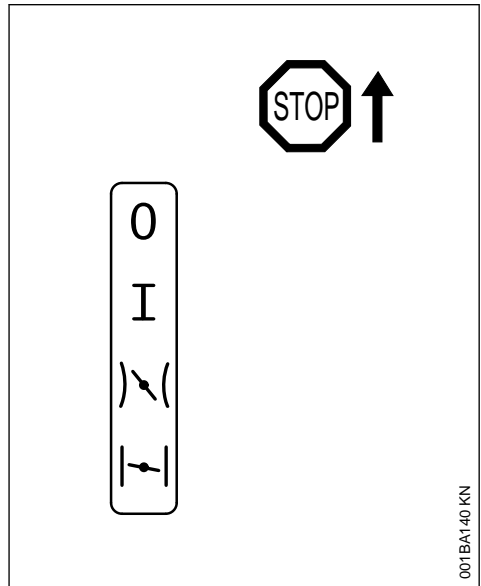

Stop 0 – engine off – ignition is switched off



Operating position I – engine is running or can start



Warm start  – this position is for starting the warm engine – the master control lever returns to the operating position when the throttle trigger is squeezed

Cold start  – this position is for starting the cold engine

18.2 Adjusting the master control lever

To adjust the master control lever from the operating position **I** to cold start , press and hold down the throttle trigger lockout and throttle trigger simultaneously – set master control lever.

To set the master control lever to warm start , first set it to cold start , then push the master control lever into the warm start  position.

Switching to the warm start  position is only possible from the cold start  position.

Simultaneously pressing the throttle trigger lock-out and blipping the throttle trigger causes the master control lever to jump from the warm start **0** position to the operating position **I**.

To switch off the engine, set the master control lever to Stop **0**.

18.2.1 Position choke shutter closed

- if the engine is cold
- if the engine stalls during opening of throttle after starting
- If the fuel tank has run empty (engine stalled out)

18.2.2 Position starting acceleration

- if engine is warm (once the engine has been running for approx. one minute)
- When the engine has turned over for the first time
- after ventilation of the combustion chamber, if the engine was flooded

18.3 Fuel pump

Press the fuel pump bulb several times – even if it is still full of fuel:

- When starting for the first time
- If the fuel tank has run empty (engine stalled out)

18.4 Holding the chain saw

There are two ways to hold the chain saw during starting.

18.4.1 On the ground

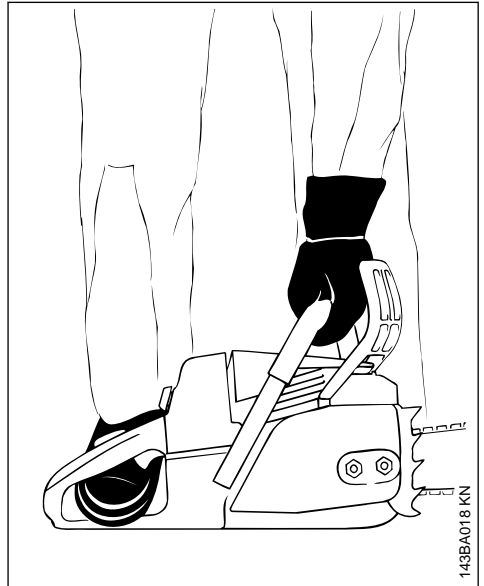

- ▶ Place the chain saw securely on the ground – assume a steady stance – the saw chain must not touch any objects and also must not touch the ground
- ▶ With the left hand on handlebar, press the chain saw firmly against the ground – thumb wrapped around the handlebar
- ▶ Place your right foot through the rear handle

18.4.2 Between the knees or thighs

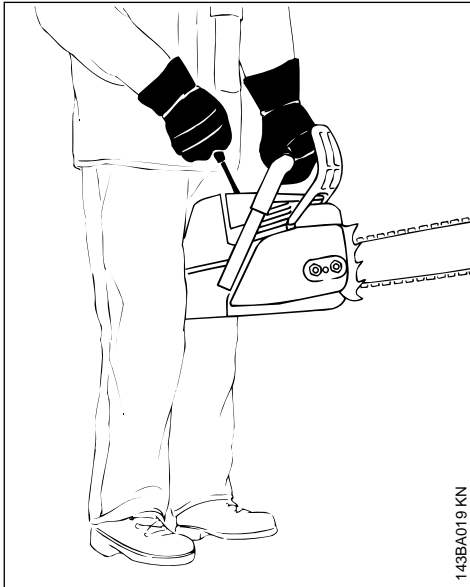

- ▶ clamp the rear handle between the knees or thighs
- ▶ grip the handlebar firmly with the left hand – thumb wrapped around the handlebar

18.5 Starting

18.5.1 Standard versions

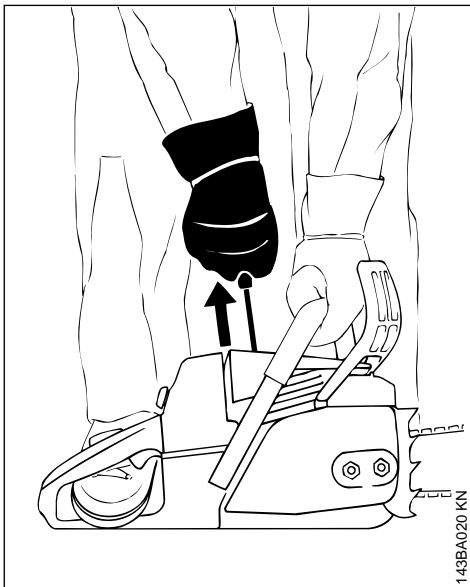

- ▶ with the right hand, pull the starter grip slowly until you feel it engage – and then give it a brisk strong pull – simultaneously press down on the handlebar – do not pull the starter rope out all the way – **risk of breakage!** Do not let the starter grip snap back – guide it vertically back into the housing so that the starter rope can rewind properly

With a new engine or after a long period of dis-use, with machines without an additional manual fuel pump, it may be necessary to pull the starter rope several times – to prime the fuel line.

18.5.2 Versions with ErgoStart



WARNING

This machine is extremely simple and easy to start, even for children – **risk of accident!**

Make absolutely certain that children or other unauthorized persons cannot attempt to start the machine:

- never leave the machine unattended during work breaks
- secure storage after work

The ErgoStart stores the energy for starting the chain saw. For this reason, a few seconds may pass between the pulling of the starter rope and the starting of the engine.

For versions with ErgoStart, there are two ways to start the machine:

- ▶ pull the starter grip slowly and smoothly – **or** – with the right hand, pull the starter grip in several short pulls of the starter rope, pulling the rope out only a little bit each time
- ▶ during starting, press down on the handlebar – do not pull out the starter rope all the way – **risk of breakage!**
- ▶ Do not let the starter grip snap back – guide it vertically back into the housing so that the starter rope can rewind properly

18.6 Starting the chain saw



WARNING

There must not be anyone within the swivel range of the chain saw.

- ▶ Observe safety precautions

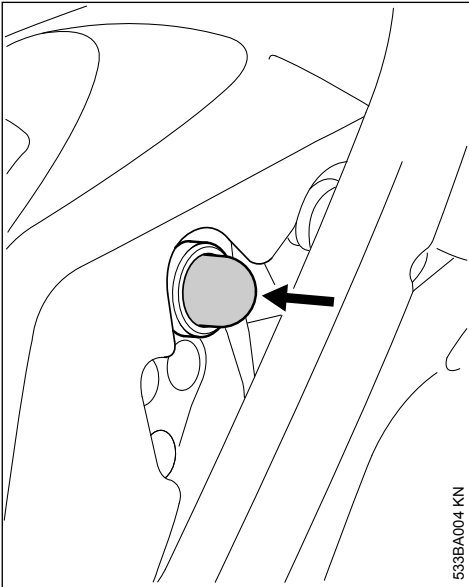
18.6.1 Versions with fuel pump

533BA004 KN

- ▶ Press the fuel pump bulb at least five times – even if it is still full of fuel

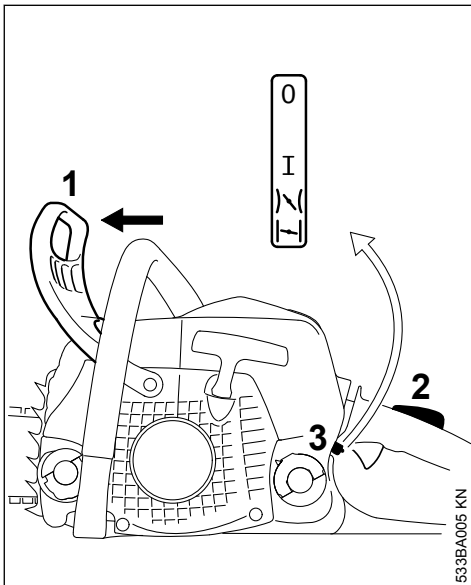
18.6.2 For all versions

533BA005 KN

- ▶ Push the hand guard (1) forwards – the saw chain is blocked

- ▶ Simultaneously press the throttle trigger lock-out (2) and throttle trigger – set the master control lever (3):

Position choke shutter closed

- if engine is cold (even if the engine has stalled during opening of throttle after starting)

Position starting acceleration

- if engine is warm (once the engine has been running for approx. one minute)
- ▶ Hold and start the chain saw

18.7 When the engine has turned over for the first time

- ▶ Move the master control lever to the position starting acceleration
- ▶ Hold and start the chain saw

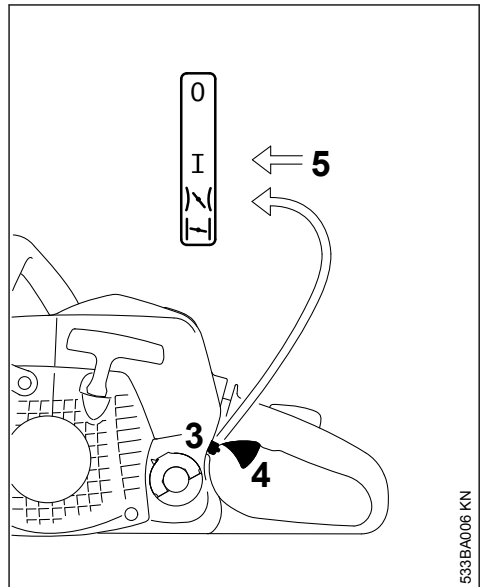
18.8 Once the engine is running

533BA006 KN

- ▶ Press the throttle trigger lockout and blip the throttle trigger (4); the master control lever (3) jumps to the operating position I and the engine begins to idle

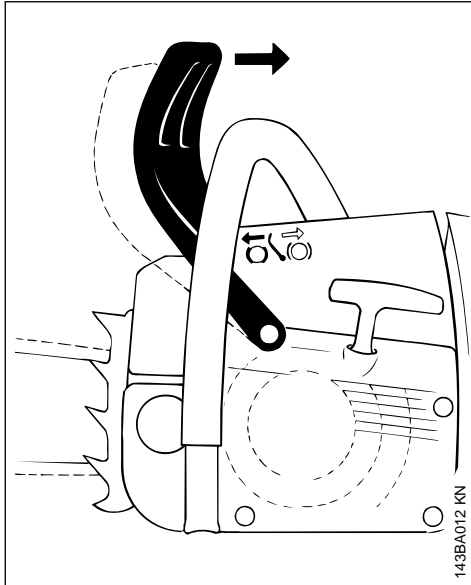

- ▶ Pull the hand guard toward the handlebar

The chain brake is released – the chain saw is ready for use.

NOTICE

Open the throttle only when the chain brake is off. Increased engine speeds with the chain brake on (saw chain is stationary) will quickly damage the clutch and chain brake.

18.9 At very low temperatures

- ▶ let the engine warm up briefly with the throttle slightly open

18.10 Switch off the engine

- ▶ Move the master control lever to the stop position 0

18.11 If the engine does not start

The master control lever was not returned from the position choke shutter closed H to starting acceleration H in time, the engine may be flooded.

- ▶ Move the master control lever to the stop position 0
- ▶ Remove the spark plug – see "Spark plug"
- ▶ Dry spark plug
- ▶ Crank the engine several times with the starter – to clear the combustion chamber
- ▶ Replace the spark plug – see "Spark plug"

- ▶ Set the master control lever to starting acceleration H – even if the engine is cold
- ▶ Restart the engine

19 Operating Instructions

19.1 During the break-in period

A factory new machine should not be run at high revs (full throttle off load) for the first three tank fillings. This avoids unnecessarily high loads during the break-in period. As all moving parts have to bed in during the break-in period, the frictional resistances in the shortblock are greater during this period. The engine develops its maximum power after about 5 to 15 tank fillings.

19.2 During work

NOTICE

Do not make the mixture leaner to achieve an apparent increase in power – this could damage the engine – see "Adjusting the Carburetor".

NOTICE

Open the throttle only when the chain brake is off. Running the engine at high revs with the chain brake engaged (chain locked) will quickly damage the shortblock and chain drive (clutch, chain brake).

19.2.1 Check chain tension frequently

A new saw chain must be retensioned more frequently than one that has been in use already for an extended period.

19.2.2 Chain cold

Tension is correct when the chain fits snugly against the underside of the bar but can still be pulled along the bar by hand. Retension if necessary – see "Tensioning the Saw Chain".

19.2.3 Chain at operating temperature

The chain stretches and begins to sag. The drive links must not come out of the bar groove on the underside of the bar – the chain may otherwise jump off the bar. Retension the chain – see "Tensioning the Saw Chain".

NOTICE

The chain contracts as it cools down. If it is not slackened off, it can damage the crankshaft and bearings.

19.2.4 After a long period of full-throttle operation

After a long period of full-throttle operation, allow engine to run for a while at idle speed so that the heat in the engine can be dissipated by flow of cooling air. This protects engine-mounted components (ignition, carburetor) from thermal overload.

19.3 After finishing work

- ▶ Slacken off the chain if you have retensioned it at operating temperature during work.

NOTICE

Always slacken off the chain again after finishing work. The chain contracts as it cools down. If it is not slackened off, it can damage the crankshaft and bearings.

19.3.1 Short-term storage

Wait for engine to cool down. Keep the machine with a full tank of fuel in a dry place, well away from sources of ignition, until you need it again.

19.3.2 Long-term storage

See "Storing the machine"

20 Taking Care of the Guide Bar

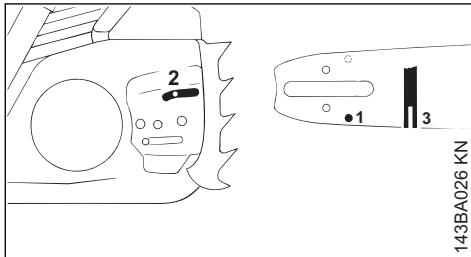

- ▶ Turn the guide bar over – every time you sharpen the chain and every time you replace the chain – this helps avoid one-sided wear, especially at the nose and underside of the bar.
- ▶ Regularly clean the oil inlet hole (1), the oil-way (2) and the bar groove (3)

- ▶ Measure the groove depth – with the scale on the filing gauge (special accessory) – in the area used most for cutting

Chain type	Chain pitch	Minimum groove depth
Picco	1/4" P	4.0 mm
Rapid	1/4"	4.0 mm
Picco	3/8" P	5.0 mm
Rapid	3/8"; 0.325"	6.0 mm
Rapid	0.404"	7.0 mm

If groove depth is less than specified:

- ▶ Replace the guide bar

The drive link tangs will otherwise scrape along the bottom of the groove – the cutters and tie straps will not ride on the bar rails.

21 Shroud

21.1 Removing the shroud

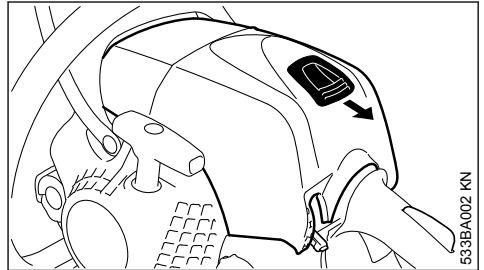

- ▶ Squeeze the throttle trigger and move the Master Control lever to  .
- ▶ Slide the lock to the rear.
- ▶ Remove the shroud upwards to the rear.

21.2 Installing the shroud

- ▶ Refit the shroud and secure it with the lock.

22 Air Filter System

The air filter system can be adapted to suit different operating conditions by installing a choice of filters. Changing the filter is quick and simple.

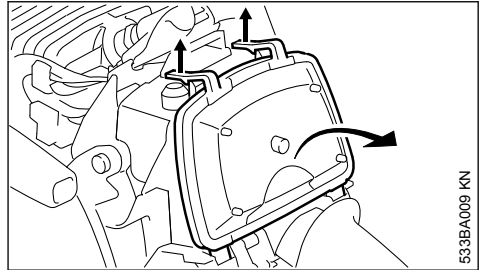
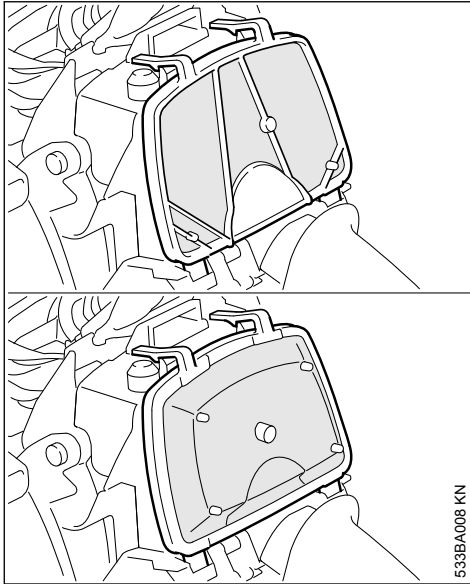

- ▶ Push the two locking tabs upwards, tilt the air filter towards the rear handle and remove.

NOTICE

To avoid damaging the filter, do not use tools for removing and installing the air filter.

- ▶ Blow out the filter with compressed air from the clean air side.

If the filter fabric is caked with dirt or no compressed air is available:

- ▶ Wash the filter in a clean, non-flammable solution (e.g. warm soapy water) and then dry.
- ▶ Reinstall the air filter.
- ▶ Install the shroud – see "Shroud".

22.1 Fleece mat (MS 171)

Top illustration.

22.2 One-piece fleece filter with sealing lip (MS 181, MS 211)

Bottom illustration, special accessory on MS 171.

22.3 One-piece fabric filter (special accessory)

For damp and extremely cold operating conditions.

23 Cleaning the Air Filter

23.1 If there is a noticeable loss of engine power

- ▶ Remove the shroud – see "Shroud".
- ▶ Always replace damaged filters.
- ▶ Clean away loose dirt from around the filter.

24 Adjusting the Carburetor

24.1 General Information

The carburetor comes from the factory with a standard setting.

This setting provides an optimum fuel-air mixture under most operating conditions.

24.2 Preparations

- ▶ Shut off the engine.
- ▶ Check the air filter and clean or replace if necessary.
- ▶ Check the spark arresting screen (not in all models, country-specific) in the muffler and clean or replace if necessary.

24.3 Standard Setting

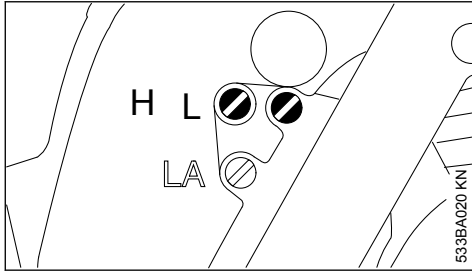

- ▶ Turn high speed screw (H) counterclockwise as far as stop (no more than 3/4 turn).
- ▶ Turn the low speed screw (L) clockwise as far as stop, then turn it back 1/4 turn.

24.4 Adjusting Idle Speed

- ▶ Carry out the standard setting.
- ▶ Start and warm up the engine.

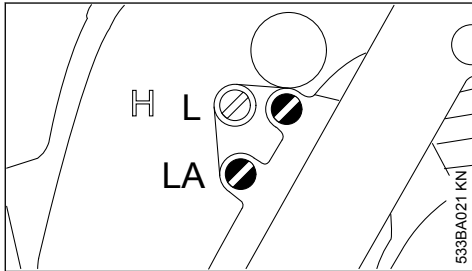

24.4.1 Engine stops while idling

- ▶ Turn the idle speed screw (LA) clockwise until the chain begins to run – then back it off 2 turns.

24.4.2 Saw chain runs while engine is idling

- ▶ Turn the idle speed screw (LA) counterclockwise until the chain stops moving – then turn it another 2 turns in the same direction.

! WARNING

If the chain continues moving when the engine is idling, have your saw checked and repaired by your servicing dealer.

24.4.3 Erratic idling behavior, poor acceleration (even though standard setting of low speed screw is correct)

Idle setting is too lean

- ▶ Turn the low speed screw (L) carefully counterclockwise, no further than stop, until the engine runs smoothly and accelerates well.

It is usually necessary to change the setting of the idle speed screw (LA) after every correction to the low speed screw (L).

24.5 Fine Tuning for Operation at High Altitude

A slight correction of the setting may be necessary if the engine does not run satisfactorily:

- ▶ Carry out the standard setting.
- ▶ Warm up the engine.
- ▶ Turn high speed screw (H) slightly clockwise (leaner) – no further than stop.

NOTICE

After returning from high altitude, reset the carburetor to the standard setting.

If the setting is too lean there is a risk of engine damage due to insufficient lubrication and overheating.

25 Spark Plug

- ▶ If the engine is down on power, difficult to start or runs poorly at idle speed, first check the spark plug.
- ▶ Fit a new spark plug after about 100 operating hours – or sooner if the electrodes are badly eroded. Install only suppressed spark plugs of the type approved by STIHL – see "Specifications".

25.1 Removing the spark plug

- ▶ Remove the shroud – see "Shroud".

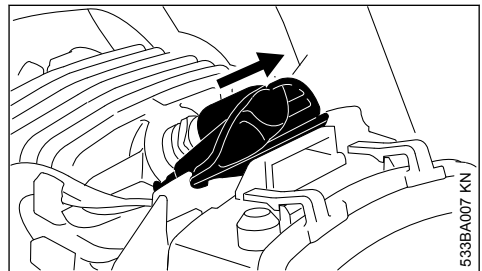

- ▶ Pull off the spark plug boot.
- ▶ Unscrew the spark plug.

25.2 Checking the Spark Plug

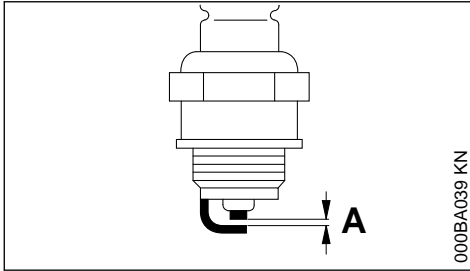

000BA039 KN

- ▶ Clean dirty spark plug.
- ▶ Check electrode gap (A) and readjust if necessary – see "Specifications".
- ▶ Rectify the problems which have caused fouling of the spark plug.

Possible causes are:

- Too much oil in fuel mix.
- Dirty air filter.
- Unfavorable running conditions.

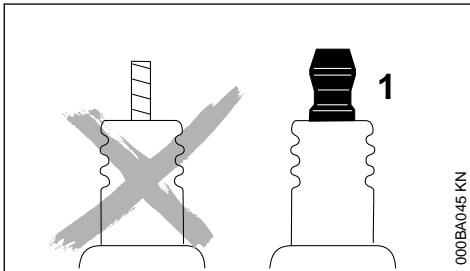

000BA045 KN

! WARNING

Arcing may occur if the adapter nut (1) is loose or missing. Working in an easily combustible or explosive atmosphere may cause a fire or an explosion. This can result in serious injuries or damage to property.

- ▶ Use resistor type spark plugs with a properly tightened adapter nut.

25.3 Installing the spark plug

- ▶ Install the spark plug and connect the spark plug boot (press it down firmly) – reassembly all other parts in the reverse sequence.

26 Engine Running Behavior

If engine running behavior is unsatisfactory even though the air filter is clean and the carburetor is properly adjusted, the cause may be the muffler.

Have the muffler checked for contamination (carbonization) by your servicing dealer.

STIHL recommends that you have servicing and repair work carried out exclusively by an authorized STIHL servicing dealer.

27 Storing the Machine

For periods of about 30 days or longer

- ▶ Drain and clean the fuel tank in a well-ventilated area.
- ▶ Dispose of fuel properly in accordance with local environmental requirements.
- ▶ If a manual fuel pump is fitted: Press the manual fuel pump at least 5 times.
- ▶ Start the engine and run it at idling speed until it stops.
- ▶ Remove saw chain and guide bar; clean and spray with protective oil
- ▶ Thoroughly clean the machine – pay special attention to the cylinder fins and air filter
- ▶ When using biological chain oil (e.g. STIHL BioPlus), fill the lubricant oil tank
- ▶ Store the machine in a dry and secure location. Keep out of the reach of children and other unauthorized persons

28 Checking and Replacing the Chain Sprocket

- ▶ Remove chain sprocket cover, saw chain and guide bar.
- ▶ Release chain brake – pull hand guard against the front handle

28.1 Fit new chain sprocket

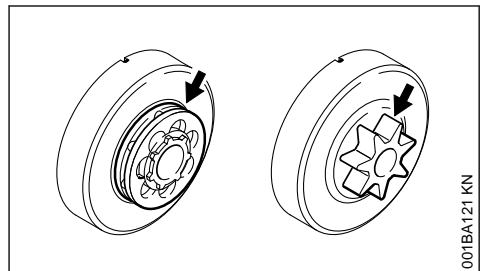

001BA121 KN

- after use of two saw chains or earlier
- if the wear marks (arrows) are deeper than 0.5 mm – otherwise the service life of the saw chain is reduced – use check gauge (special accessory) to test

Using two saw chains in alternation helps preserve the chain sprocket.

STIHL recommends use of original STIHL chain sprockets in order to ensure optimal functioning of the chain brake.

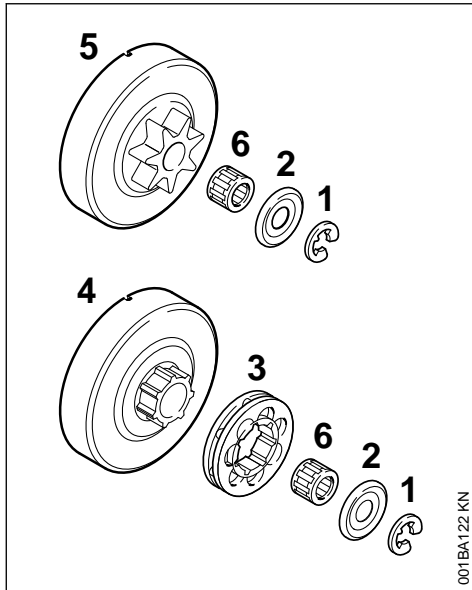

- ▶ Use a screwdriver to remove the E-clip (1)
- ▶ Remove the washer (2)
- ▶ Remove rim sprocket (3)
- ▶ Inspect transport profile on the clutch drum (4) – if there are also heavy signs of wear, also replace the clutch drum
- ▶ Remove clutch drum or spur chain sprocket (5) including needle cage (6) from the crankshaft – with QuickStop Super chain brake, press throttle trigger lockout beforehand

28.2 Install spur chain sprocket / rim sprocket

- ▶ Clean crankshaft stub and needle cage and lubricate with STIHL lubricant (special accessory)
- ▶ Slide needle cage onto the crankshaft stub
- ▶ After refitting, turn the clutch drum and/or spur chain sprocket approx. 1 full turn so that the carrier for the oil pump drive engages – with QuickStop Super chain brake, press throttle trigger lockout beforehand
- ▶ Refit the rim sprocket – cavities toward the outside
- ▶ Refit washer and E-clip on the crankshaft

29 Maintaining and Sharpening the Saw Chain

29.1 Sawing effortlessly with a properly sharpened saw chain

A properly sharpened saw chain cuts through wood effortlessly even with very little pushing.

Never use a dull or damaged saw chain – this leads to increased physical strain, increased vibration load, unsatisfactory cutting results and increased wear.

- ▶ Clean the saw chain
- ▶ Check the saw chain for cracks and damaged rivets
- ▶ Replace damaged or worn chain components and adapt these parts to the remaining parts in terms of shape and level of wear – rework accordingly

Carbide-tipped (Duro) saw chains are especially wear-resistant. For an optimal sharpening result, STIHL recommends STIHL servicing dealers.

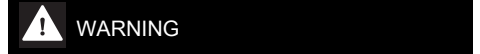

Compliance with the angles and dimensions listed below is absolutely necessary. An improperly sharpened saw chain – especially depth gauges that are too low – can lead to increased kickback tendency of the chain saw – **risk of injury!**

29.2 Chain pitch

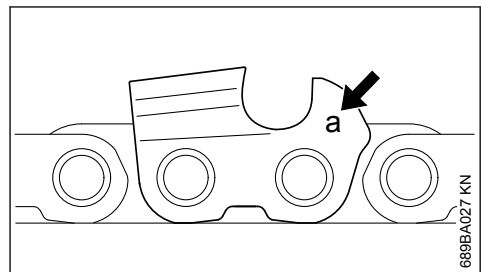

The chain pitch marking (a) is embossed in the area of the depth gauge of each cutter.

Marking (a)	Chain pitch	
	Inches	mm
7	1/4 P	6.35
1 or 1/4	1/4	6.35
6, P or PM	3/8 P	9.32
2 or 3/25	0.325	8.25
3 or 3/8	3/8	9.32
4 or 4/4	0.404	10.26

The diameter of file to be used depends on the chain pitch – see table "Sharpening tools".

The angles of the cutter must be maintained during resharpening.

29.3 Sharpening and side plate angles

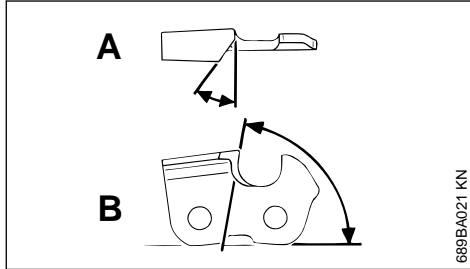

A Sharpening angle

STIHL saw chains are sharpened with a 30° sharpening angle. Ripping chains, which are sharpened with a 10° sharpening angle, are exceptions. Ripping chains have an X in the designation.

B Side plate angle

The correct side plate angle results automatically when the specified file holder and file diameter are used.

Tooth shapes	Angle (°)	
	A	B
Micro = semi-chisel tooth, e. g., 63 PM3, 26 RM3, 36 RM	30	75
Super = full chisel tooth, e. g., 63 PS3, 26 RS, 36 RS3	30	60
Ripping chain, e. g., 63 PMX, 36 RMX	10	75

The angles must be identical for all cutters in the saw chain. Varying angles: Rough, uneven running of the saw chain, increased wear – even to the point of saw chain breakage.

29.4 File holder

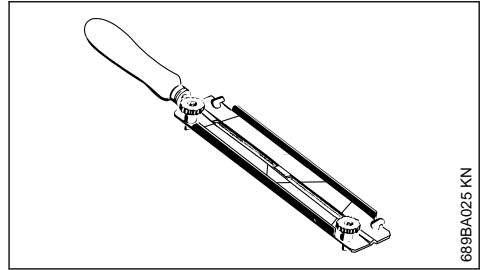

► Use a file holder

Always use a file holder (special accessory, see table "Sharpening tools") when sharpening saw chains by hand. File holders have markings for the sharpening angle.

Use only special saw chain files! Other files are unsuitable in terms of shape and type of cutting.

29.5 To check the angles

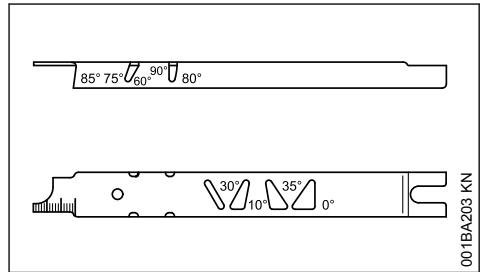

STIHL filing gauge (special accessory, see table "Sharpening tools") – a universal tool for checking sharpening and side plate angles, depth gauge setting, and tooth length, as well as cleaning grooves and oil inlet holes.

29.6 Proper sharpening

- Select sharpening tools in accordance with chain pitch
- Clamp guide bar if necessary
- Block saw chain – push the hand guard forward
- To advance the saw chain, pull the hand guard toward the handlebar: The chain brake is disengaged. With the Quickstop Super chain brake system, additionally press the throttle trigger lockout
- Sharpen frequently, removing little material – two or three strokes of the file are usually sufficient for simple resharpening

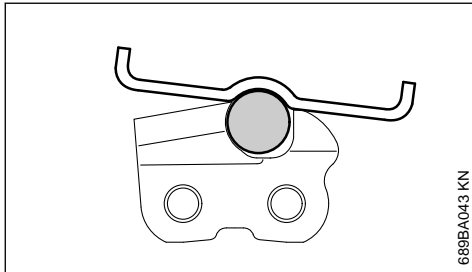
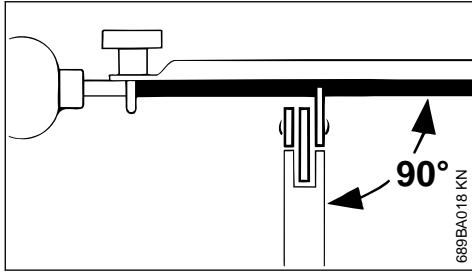

- ▶ Guide the file: **horizontally** (at a right angle to the side surface of the guide bar) in accordance with the specified angle – according to the markings on the file holder – rest the file holder on the tooth head and the depth gauge
- ▶ File only from the inside outward
- ▶ The file only sharpens on the forward stroke – lift the file on the backstroke
- ▶ Do not file tie straps and drive links
- ▶ Rotate the file a little periodically in order to avoid uneven wear
- ▶ To remove file burr, use a piece of hardwood
- ▶ Check angle with file gauge

All cutters must be equally long.

With varying cutter lengths, the cutter heights also vary and cause rough running of the saw chain and chain breakage.

- ▶ All cutters must be filed down equal to the length of the shortest cutter – ideally, one should have this done by a servicing dealer using an electric sharpener

29.7 Depth gauge setting

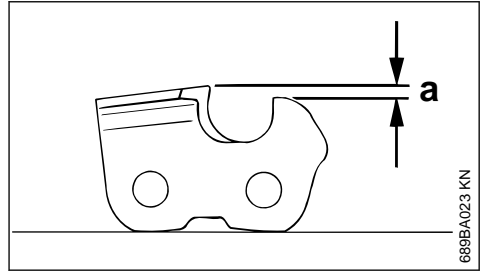

The depth gauge determines the depth to which the cutter penetrates the wood and thus the chip thickness.

a Required distance between depth gauge and cutting edge

When cutting softwood outside of the frost season, the distance can be increased by up to 0.2 mm (0.008").

Chain pitch		Depth gauge Distance (a)	
Inches	(mm)	mm	(Inches)
1/4 P	(6.35)	0.45	(0.018)
1/4	(6.35)	0.65	(0.026)
3/8 P	(9.32)	0.65	(0.026)
0.325	(8.25)	0.65	(0.026)
3/8	(9.32)	0.65	(0.026)
0.404	(10.26)	0.80	(0.031)

29.8 Lowering the depth gauges

The depth gauge setting is lowered when the cutter is sharpened.

- ▶ Check the depth gauge setting after each sharpening

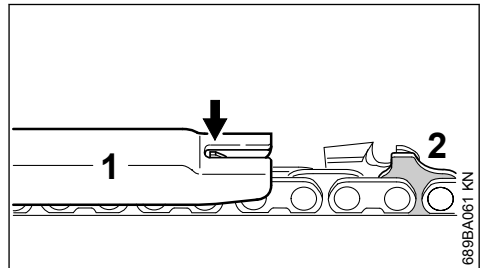

- ▶ Lay the appropriate file gauge (1) for the chain pitch on the saw chain and press it against the cutter to be checked – if the depth gauge protrudes past the file gauge, the depth gauge must be reworked

Saw chains with humped drive link (2) – upper part of the humped drive link (2) (with service

mark) is lowered at the same time as the depth gauge of the cutter.

! WARNING

The rest of the humped drive link must not be filed; otherwise, this could increase the tendency of the chain saw to kick back.

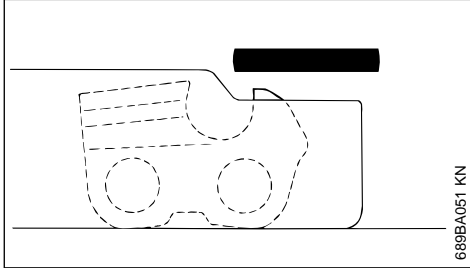

- Rework the depth gauge so that it is flush with the file gauge

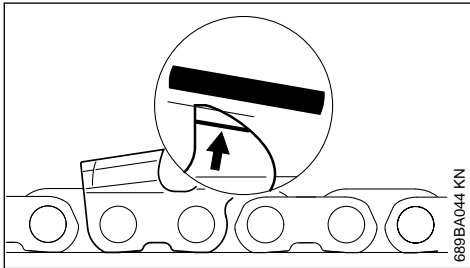

- Afterwards, dress the leading edge of the depth gauge parallel to the service mark (see arrow) – when doing this, be careful not to further lower the highest point of the depth gauge

! WARNING

Depth gauges that are too low increase the kick-back tendency of the chain saw.

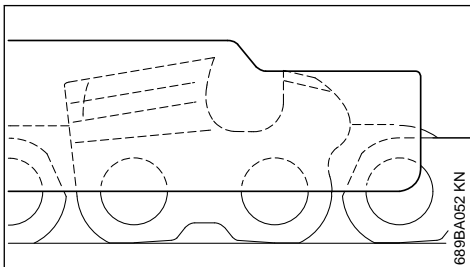

- Lay the file gauge on the saw chain – the highest point of the depth gauge must be flush with the file gauge
- After sharpening, clean the saw chain thoroughly, removing any filings or grinding dust – lubricate the saw chain thoroughly
- In the event of extended periods of disuse, store saw chains in cleaned and oiled condition

Sharpening tools (special accessories)								
Chain pitch		Round file Ø		Round file	File holder	File gauge	Taper square file	Sharpening set ¹⁾
Inches	(mm)	mm	(Inches)	Part number	Part number	Part number	Part number	Part number
1/4P	(6.35)	3.2	(1/8)	5605 771 3206	5605 750 4300	0000 893 4005	0814 252 3356	5605 007 1000
1/4	(6.35)	4.0	(5/32)	5605 772 4006	5605 750 4327	1110 893 4000	0814 252 3356	5605 007 1027
3/8 P	(9.32)	4.0	(5/32)	5605 772 4006	5605 750 4327	1110 893 4000	0814 252 3356	5605 007 1027
0.325	(8.25)	4.8	(3/16)	5605 772 4806	5605 750 4328	1110 893 4000	0814 252 3356	5605 007 1028
3/8	(9.32)	5.2	(13/64)	5605 772 5206	5605 750 4329	1110 893 4000	0814 252 3356	5605 007 1029
0.404	(10.26)	5.5	(7/32)	5605 772 5506	5605 750 4330	1106 893 4000	0814 252 3356	5605 007 1030

¹⁾consisting of file holder with round file, taper square file and file gauge

30 Maintenance and Care

The following maintenance intervals apply for normal operating conditions only. When working under difficult conditions (high accumulation of dust, highly resinous lumber, lumber from tropical trees, etc.) or longer than normal each day, the specified intervals must be shortened accordingly. If you only use the tool occasionally, extend the intervals accordingly.		Before starting work	At the end of work and/or daily	Whenever tank is refilled	Weekly	Monthly	Annually	If faulty	If damaged	As required
Complete machine	Visual inspection (condition, leaks)	X		X						
	Clean		X							
Throttle trigger, throttle trigger lockout, choke lever, stop switch, master control lever (dependent on equipment)	Function test	X		X						
Chain brake	Function test	X		X						
	Have checked by dealer ¹⁾									X
Manual fuel pump (if present)	check	X								
	Have repaired by a specialist dealer ¹⁾								X	
Fuel pick-up body / filter in fuel tank	check					X				
	Clean, replace filter insert					X		X		
	replace						X		X	X
Fuel tank	Clean					X				
Lubricating oil tank	Clean					X				

¹⁾ STIHL recommends STIHL servicing dealer

²⁾ When using professional chainsaws (with a power output of 3.4 kW or more) for the first time, tighten the cylinder block screws after 10 to 20 hours of operation

The following maintenance intervals apply for normal operating conditions only. When working under difficult conditions (high accumulation of dust, highly resinous lumber, lumber from tropical trees, etc.) or longer than normal each day, the specified intervals must be shortened accordingly. If you only use the tool occasionally, extend the intervals accordingly.		Before starting work	At the end of work and/or daily	Whenever tank is refilled	Weekly	Monthly	Annually	if faulty	if damaged	As required
Chain lubrication	check	X								
Saw chain	Check, pay attention to sharpness	X		X						
	Checking the chain tension sharpen	X		X						X
Guide bar	Check (wear, damage)	X								
	Clean and turn over									X
	Deburr replace				X				X	X
Chain sprocket	check			X						
Air filter	Clean						X		X	
	replace							X		
Anti-vibration elements	check	X					X			
	Have replaced by servicing dealer ¹⁾							X		
Air intake on fan housing	Clean		X	X						X
Cylinder fins	Clean		X		X					X
Carburetor	Check idle adjustment – saw chain must not rotate	X		X						
	Set the idle speed; if required have the chainsaw repaired by a specialist dealer ¹⁾									X
Spark plug	Adjust electrode gap							X		
	Replace after 100 hours of operation									
Accessible screws and nuts (except adjusting screws)	Tighten ²⁾									X
Chain catcher	check	X								
	replace								X	
Safety information label	replace								X	

¹⁾ STIHL recommends STIHL servicing dealer

²⁾ When using professional chainsaws (with a power output of 3.4 kW or more) for the first time, tighten the cylinder block screws after 10 to 20 hours of operation

31 Minimize Wear and Avoid Damage

Observing the instructions in this manual helps reduce the risk of unnecessary wear and damage to the power tool.

The power tool must be operated, maintained and stored with the due care and attention described in this owner's manual.

The user is responsible for all damage caused by non-observance of the safety precautions, operating and maintenance instructions in this manual. This includes in particular:

- Alterations or modifications to the product not approved by STIHL.
- Using tools or accessories which are neither approved or suitable for the product or are of a poor quality.
- Using the product for purposes for which it was not designed.
- Using the product for sports or competitive events.
- Consequential damage caused by continuing to use the product with defective components.

31.1 Maintenance Work

All the operations described in the "Maintenance Chart" must be performed on a regular basis. If these maintenance operations cannot be performed by the owner, they should be performed by a servicing dealer.

STIHL recommends that you have servicing and repair work carried out exclusively by an authorized STIHL servicing dealer. STIHL dealers are regularly given the opportunity to attend training courses and are supplied with the necessary technical information.

If these maintenance operations are not carried out as specified, the user assumes responsibility for any damage that may occur. Among other parts, this includes:

- Damage to the engine due to neglect or deficient maintenance (e.g. air and fuel filters), incorrect carburetor adjustment or inadequate cleaning of cooling air inlets (intake ports, cylinder fins).
- Corrosion and other consequential damage resulting from improper storage.
- Damage to the machine resulting from the use of poor quality replacement parts.

31.2 Parts Subject to Wear and Tear

Some parts of the power tool are subject to normal wear and tear even during regular operation in accordance with instructions and, depending on the type and duration of use, have to be replaced in good time. Among other parts, this includes:

- Saw chain, guide bar
- Drive components (clutch, clutch drum, chain sprocket)
- Filters (air, oil, fuel)
- Starter mechanism
- Spark plug
- Components of antivibration system

32 Main Parts

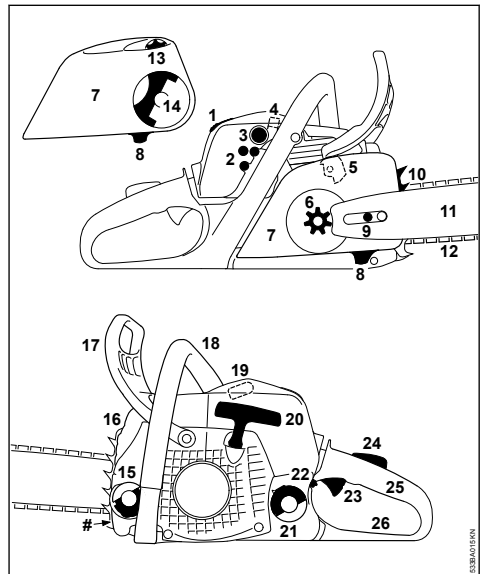

- 1 Shroud slide
- 2 Carburetor adjusting screws
- 3 Manual fuel pump (Easy Start¹⁾)
- 4 Slide (summer operation/ winter operation, MS 211 only)
- 5 Chain brake
- 6 Chain sprocket
- 7 Chain sprocket cover
- 8 Chain catcher
- 9 Side chain tensioner
- 10 Bumper spike
- 11 Guide bar

- 12 Oilomatic saw chain
- 13 Adjusting wheel (quick tensioner)
- 14 Wings of the wing nut¹⁾ (quick tensioner)
- 15 Oil filler cap
- 16 Muffler
- 17 Front hand guard
- 18 Front handle (handlebar)
- 19 Spark plug boot
- 20 Starter grip
- 21 Fuel tank twist lock
- 22 Master Control lever
- 23 Throttle trigger
- 24 Throttle trigger interlock
- 25 Rear handle
- 26 Rear hand guard
- # Serial number

33 Specifications

33.1 Engine

STIHL single cylinder two-stroke engine

33.1.1 MS 171, MS 171 C

Displacement:	31.8 cc
Bore:	38 mm
Stroke:	28 mm
Engine power to ISO 7293:	1.3 kW (1.8□bhp) at 10,000□rpm
Idle speed: ¹⁾	2,800□rpm

33.1.2 MS 181, MS 181 C

Displacement:	31.8 cc
Bore:	38 mm
Stroke:	28 mm
Engine power to ISO 7293:	1.5 kW (2.0 bhp) at 10,000 rpm
Idle speed: ¹⁾	2,800□rpm

33.1.3 MS 211, MS 260 C

Displacement:	35.2□cc
Bore:	40 mm
Stroke:	28 mm
Engine power to ISO 7293:	1.7 kW (2.3 bhp) at 10,000 rpm
Idle speed: ¹⁾	2,800□rpm

33.2 Ignition System

Electronic magneto ignition

Spark plug (resistor type):	NGK CMR6H BOSCH USR4AC
Electrode gap:	0.5 mm

33.3 Fuel System

All position diaphragm carburetor with integral fuel pump

Fuel tank capacity:	270 cc (0.27 l)
---------------------	-----------------

33.4 Chain Lubrication

Fully automatic, speed-controlled oil pump with rotary piston

Oil tank capacity:	265 cc (0.265 l)
--------------------	------------------

33.5 Weight

dry, without bar and chain

MS 171:	4.3 kg
MS 171 C:	4.6 kg
MS 181:	4.3 kg
MS 181 C:	4.6 kg
MS 211:	4.3 kg
MS 211 C:	4.6 kg

33.6 Cutting Attachments for MS 171, MS 171 C, MS 181, MS 181 C

Actual cutting length may be less than the specified length

33.6.1 Rollomatic E Mini Light guide bars

Cutting lengths:	30, 35 cm
Pitch:	3/8" P (9.32 mm)
Groove width:	1.1 mm
Nose sprocket:	7-tooth

33.6.2 Rollomatic E Mini guide bars

Cutting lengths:	30, 35, 40 cm
Pitch:	3/8" P (9.32 mm)
Groove width:	1.1 mm
Nose sprocket:	7-tooth

33.6.3 3/8" Picco chain

Picco Micro Mini 3 (61 PMM3) Type 3610

Pitch:	3/8" P (9.32 mm)
Drive link gauge:	1.1 mm

33.6.4 Chain Sprocket

6-tooth for 3/8" P (spur sprocket)

¹⁾ According to version

¹⁾ to ISO 11681 +/- 50 rpm

Max. chain speed according to ISO 11681: 24.8 m/s
Chain speed at maximum power: 18.6 m/s

33.7 Cutting Attachments for MS 211, MS 211 C

Actual cutting length may be less than the specified length

33.7.1 Rollomatic E Light and Rollomatic E guide bars

Cutting lengths: 30, 35, 40 cm
Pitch: 3/8" P (9.32 mm)
Groove width: 1.3 mm
Nose sprocket: 9-tooth

33.7.2 3/8" Picco chains

Picco Micro 3 (63 PM3) Type 3636
Picco Duro 3 (63 PD3) Type 3612
Picco Super 3 (63 PS3) Type 3616
Pitch: 3/8" P (9.32 mm)
Drive link gauge: 1.3 mm

33.7.3 Chain Sprocket

6-tooth for 3/8" P (spur sprocket)
Max. chain speed according to ISO 11681: 24.8 m/s
Chain speed at maximum power: 18.6 m/s

33.8 Sound and Vibration Levels

For further details on compliance with Vibration Directive 2002/44/EC, see

www.stihl.com/vib

33.8.1 Sound pressure level L_{peq} in accordance with ISO 22868

MS 171:	99 dB(A)
MS 171 C:	99 dB(A)
MS 181:	100 dB(A)
MS 181 C:	100 dB(A)
MS 211:	100 dB(A)
MS 211 C:	100 dB(A)

33.8.2 Sound power level L_w in accordance with ISO 22868

MS 171:	112 dB(A)
MS 171 C:	112 dB(A)
MS 181:	112 dB(A)
MS 181 C:	112 dB(A)
MS 211:	113 dB(A)
MS 211 C:	113 dB(A)

33.8.3 Vibration level $a_{hv,eq}$ in accordance with ISO 22867

	Handle, left	Handle, right
MS 171:	4.0 m/s ²	4.5 m/s ²
MS 171 C:	3.5 m/s ²	3.5 m/s ²

	Handle, left	Handle, right
MS 181:	3.5 m/s ²	3.0 m/s ²
MS 181 C:	3.5 m/s ²	3.0 m/s ²
MS 211:	3.5 m/s ²	3.5 m/s ²
MS 211 C:	3.5 m/s ²	3.5 m/s ²

The K-factor in accordance with Directive 2006/42/EC is 2.0 dB(A) for the sound pressure level and sound power level; the K-factor in accordance with Directive 2006/42/EC is 2.0 m/s² for the vibration level.

33.9 REACH

REACH is an EC regulation and stands for the Registration, Evaluation, Authorization and Restriction of Chemical substances.

For information on compliance with the REACH regulation (EC) No. 1907/2006 see

www.stihl.com/reach

33.10 Exhaust Emissions

The CO₂ value measured in the EU type approval procedure is specified at

www.stihl.com/co2

in the product-specific technical data.

The measured CO₂ value was determined on a representative engine in accordance with a standardized test procedure under laboratory conditions and does not represent either an explicit or implied guarantee of the performance of a specific engine.

The applicable exhaust emission requirements are fulfilled by the intended usage and maintenance described in this User Manual. The operating license shall be void if the engine is modified in any way.

34 Ordering Spare Parts

Please enter your saw model, serial number as well as the part numbers of the guide bar and saw chain in the spaces provided. This will make re-ordering simpler.

The guide bar and saw chain are subject to normal wear and tear. When purchasing these parts, always quote the saw model, the part numbers and names of the parts.

Model

Serial number

Guide bar part number

Chain part number

35 Maintenance and Repairs

Users of this machine may only carry out the maintenance and service work described in this user manual. All other repairs must be carried out by a servicing dealer.

STIHL recommends that you have servicing and repair work carried out exclusively by an authorized STIHL servicing dealer. STIHL dealers are regularly given the opportunity to attend training courses and are supplied with the necessary technical information.

When repairing the machine, only use replacement parts which have been approved by STIHL for this power tool or are technically identical. Only use high-quality replacement parts in order to avoid the risk of accidents and damage to the machine.

STIHL recommends the use of original STIHL replacement parts.

Original STIHL parts can be identified by the STIHL part number, the **STIHL** logo and the STIHL parts symbol  (the symbol may appear alone on small parts).

36 Disposal

Contact the local authorities or your STIHL servicing dealer for information on disposal.

Improper disposal can be harmful to health and pollute the environment.

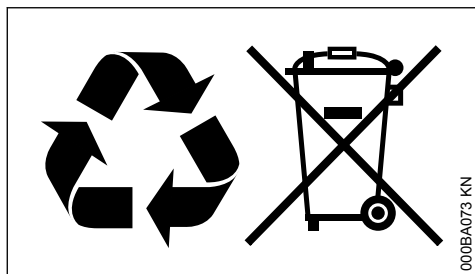

- ▶ Take STIHL products including packaging to a suitable collection point for recycling in accordance with local regulations.
- ▶ Do not dispose with domestic waste.

37 EC Declaration of Conformity

ANDREAS STIHL AG & Co. KG
Badstr. 115
D-71336 Waiblingen

Germany

declares under its sole responsibility that

Designation:	Chainsaw
Make:	STIHL
Series:	MS 171
	MS 171 C
	MS 171 C-BE
	MS 181
	MS 181 C
	MS 181 C-BE
	MS 211
	MS 211 C
	MS 211 C-BE

Serial identification number: 1139

Displacement

all MS 171:	31.8 cm ³
all MS 181:	31.8 cm ³
all MS 211:	35.2 cm ³

conforms to the relevant provisions of Directives 2011/65/EU, 2006/42/EC, 2014/30/EU and 2000/14/EC and has been developed and manufactured in compliance with the following standards in the versions valid on the date of production:

EN ISO 11681-1, EN 55012, EN 61000-6-1

The measured and the guaranteed sound power level have been determined in accordance with Directive 2000/14/EC, Annex V, and standard ISO 9207.

Measured sound power level

all MS 171:	112 dB(A)
all MS 181:	112 dB(A)
all MS 211:	113 dB(A)

Guaranteed sound power level

all MS 171:	114 dB(A)
all MS 181:	114 dB(A)
all MS 211:	115 dB(A)

The EC type examination was carried out by

KWF Services GmbH (NB 0363)
Spremberger Straße 1
D-64823 Groß-Umstadt

Certification No.

all MS 171:	K-EG -2023/4442
all MS 181:	K-EG-2023/4446

The EC type examination was carried out by
DPLF

Deutsche Prüf- und Zertifizierungsstelle für Land- und Forsttechnik GbR (NB 0363)
Spremberger Straße 1
D-64823 Groß-Umstadt

Certification No.

all MS 211: K-EG -2009/4444

Technical documents deposited at:

ANDREAS STIHL AG & Co. KG
Produktzulassung

The year of manufacture and serial number are indicated on the power tool.

Waiblingen, 2023-02-22

ANDREAS STIHL AG & Co. KG

pp



Robert Olma, Vice President, Regulatory Affairs
& Global Governmental Relations



38 UKCA Declaration of Conformity

ANDREAS STIHL AG & Co. KG
Badstr. 115
D-71336 Waiblingen

Germany

declares under its sole responsibility that

Designation:	Chainsaw
Make:	STIHL
Series:	MS 171 MS 171 C MS 171 C-BE MS 181 MS 181 C MS 181 C-BE MS 211 MS 211 C MS 211 C-BE
Serial identification number:	1139

Displacement

all MS 171:	31.8 cm ³
all MS 181:	31.8 cm ³
all MS 211:	35.2 cm ³

conforms to the relevant provisions of UK regulations The Restriction of the Use of Certain Hazardous Substances in Electrical and Electronic Equipment Regulations 2012, Supply of Machinery (Safety) Regulations 2008, Electromagnetic

Compatibility Regulations 2016 and Noise Emission in the Environment by Equipment for use Outdoors Regulations 2001 and has been manufactured in compliance with the following standards in the versions valid on the date of production:

EN ISO 11681-1, EN 55012, EN 61000-6-1

The measured and guaranteed sound power levels have been determined in accordance with UK regulation Noise Emission in the Environment by Equipment for use Outdoors Regulations 2001, Annex 8, using the ISO 9207 standard.

Measured sound power level

all MS 171:	112 dB(A)
all MS 181:	112 dB(A)
all MS 211:	113 dB(A)

Guaranteed sound power level

all MS 171:	114 dB(A)
all MS 181:	114 dB(A)
all MS 211:	115 dB(A)

The type examination was carried out by

Intertek Testing & Certification Ltd, Academy Place, 1 – 9 Brook Street, Brentwood Essex, CM14 5NQ, United Kingdom

Certification No.

all MS 171:	UK-MCR-0021
all MS 181:	UK-MCR-0022
all MS 211:	UK-MCR-0024

Technical documents deposited at:

ANDREAS STIHL AG & Co. KG

The year of manufacture and serial number are indicated on the power tool.

Waiblingen, 2022-08-01

ANDREAS STIHL AG & Co. KG

pp



Robert Olma, Vice President, Regulatory Affairs
& Global Governmental Relations



www.stihl.com



0458-533-0121-E



0458-533-0121-E