

FSA 135

STIHL



2 - 24 Instruction Manual



Contents

1	Introduction.....	2
2	Guide to Using this Manual.....	2
3	Overview.....	3
4	Safety Precautions.....	4
5	Preparing Trimmer for Operation.....	11
6	Charging the Battery, LEDs.....	12
7	Activating and Deactivating Bluetooth® Radio Interface.....	12
8	Assembling the Trimmer.....	12
9	Adjusting Trimmer for User.....	14
10	Removing and Fitting the Battery.....	15
11	Switching the Trimmer On/Off.....	15
12	Testing the Trimmer and Battery.....	16
13	Operating the Trimmer.....	16
14	After Finishing Work.....	18
15	Transporting.....	18
16	Storing.....	18
17	Cleaning.....	19
18	Maintenance.....	19
19	Repairing.....	20
20	Troubleshooting.....	20
21	Specifications.....	21
22	Combinations of Cutting Attachments, Deflectors and Carrying Systems.....	22
23	Spare Parts and Accessories.....	23
24	Disposal.....	23
25	EC Declaration of Conformity.....	23
26	UKCA Declaration of Conformity.....	24

1 Introduction

Dear Customer,

Thank you for choosing STIHL. We develop and manufacture our quality products to meet our customers' requirements. The products are designed for reliability even under extreme conditions.

STIHL also stands for premium service quality. Our dealers guarantee competent advice and instruction as well as comprehensive service support.

STIHL expressly commit themselves to a sustainable and responsible handling of natural resources. This user manual is intended to help you use your STIHL product safely and in an environmentally friendly manner over a long service life.

We thank you for your confidence in us and hope you will enjoy working with your STIHL product.

N. Stihl

Dr. Nikolas Stihl

**IMPORTANT! READ BEFORE USING AND
KEEP IN A SAFE PLACE FOR REFERENCE.**

2 Guide to Using this Manual

2.1 Applicable Documents

The local safety regulations apply.

- ▶ In addition to this User Manual, you should also read, understand and retain the following documents:
 - User Manual and packaging of the cutting attachment being used
 - User manual of the carrying system you are using
 - User Manual for STIHL AR battery
 - User Manual for "AP belt bag with connecting cable"
 - Safety notices and precautions for STIHL AP battery
 - User Manual for STIHL AL 101, 301, 301-4, 500 chargers
 - Safety information for STIHL batteries and products with built-in battery:
www.stihl.com/safety-data-sheets

For further information on STIHL connected, compatible products and FAQs, please visit www.connect.stihl.com or available from a STIHL servicing dealer.

The Bluetooth® word mark and logos are registered trademarks owned by Bluetooth SIG, Inc. These word marks/logos are used by STIHL under license.

Batteries with  are equipped with a Bluetooth® radio interface. Local operating restrictions (in aircraft or hospitals, for example) must be observed.

2.2 Symbols used with warnings in the text



- This symbol indicates dangers that can cause serious injuries or death.
 - ▶ The measures indicated can avoid serious injuries or death.

NOTICE

- This symbol indicates dangers that can cause damage to property.
 - ▶ The measures indicated can avoid damage to property.

2.3 Symbols in Text

This symbol refers to a chapter in this instruction manual.

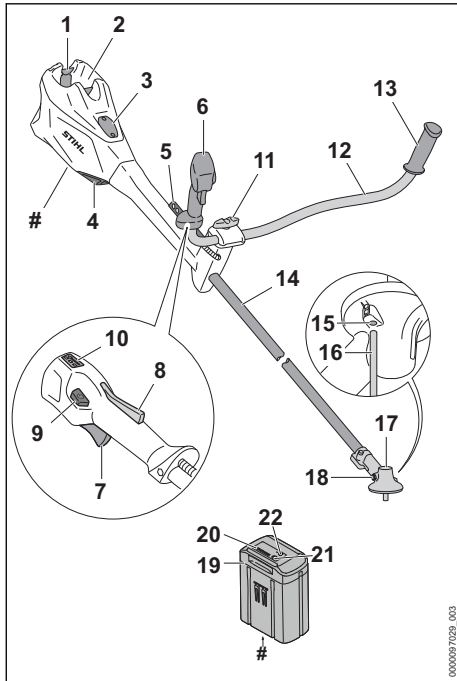
3 Overview**3.1 Brushcutter and Battery****1 Locking lever**

The locking lever holds the battery in the battery compartment.

2 Battery compartment

The battery compartment holds the battery.

3 Cover¹

The cover is the placeholder for a Smart Connector 2 A. The cover is part of the motor housing. Only remove the cover to install a Smart Connector 2 A and store it safely for later re-installation. Always use the brushcutter with the cover or Smart Connector 2 A installed.

4 Air filter

The air filter filters the air entering the engine.

5 Carrying strip

Perforated strip for suspending the carrying system.

6 Control handle

The control handle is used for operating, holding and controlling the brushcutter.

7 Trigger

The trigger switches the brushcutter on and off.

8 Trigger lockout

The trigger lockout unlocks the trigger.

9 Unlock button

The unlock button switches on the brushcutter and selects the power level.

10 LEDs

These LEDs indicate the selected power level.

11 Wing screw

The wing screw secures the handlebar to the handle support.

12 Handlebar

The handlebar connects control handle and handle with the shaft.

13 Handle

The handle is for holding and controlling the brushcutter.

14 Shaft

The shaft connects all components.

15 Opening for stop pin

The opening for the stop pin accommodates the stop pin.

16 Stop pin

The stop pin blocks the shaft while a cutting attachment is being mounted.

17 Gear housing

The gear housing encloses the gearbox.

18 Screw plug

The screw plug closes the filler opening for STIHL gear grease.

19 Battery

The battery supplies power to the brushcutter.

20 LEDs

The LEDs indicate the state of charge of the battery and any faults.

¹The cover is part of the motor housing. Only remove the cover to install a Smart Connector 2 A and store it safely for later re-installation. Always use the brushcutter with the cover or Smart Connector 2 A installed.

21 Pushbutton

The pushbutton activates the LEDs on the battery. The pushbutton activates and deactivates Bluetooth® radio interface (if available).

22 "BLUETOOTH" LED (only for batteries with)

The LED indicates the activation and deactivation of the Bluetooth® interface.

Rating plate with the machine number

3.2 Deflectors and Cutting Attachments

The illustrations show examples of deflectors and cutting attachments. Approved combinations are listed in this instruction manual,  22.

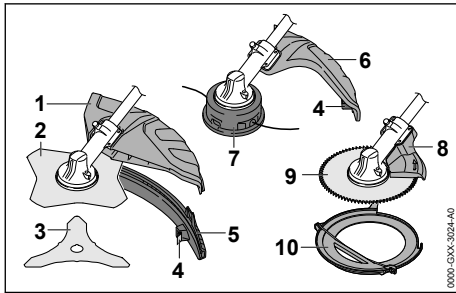

1 Universal deflector

Protects user from flying debris and contact with the cutting attachment.

2 Grass Cutting Blade

Cuts grass and weeds.

3 Brush Knife

Cuts brushwood.

4 Line Limiting Blade

Trims mowing line to correct length.

5 Skirt

Extends universal deflector for use with a mowing head.

6 Deflector for Mowing Heads

Protects user from flying debris and contact with the mowing head.

7 Mowing Head

The mowing head contains the mowing line.

8 Limit Stop

Protects user from flying debris and contact with the circular saw blade and helps support the trimmer against the wood during cutting work.

9 Circular Saw Blade

Cuts shrubs and trees.

10 Transport Guard

Helps protect user from contact with metal cutting attachments.

3.3 Symbols

Meanings of symbols that may be on the brushcutter, deflector and battery:



1 LED emits red light. The battery is too warm or too cold.



4 LEDs flash red. There is a fault in the battery.



Press the unlock button to switch the brushcutter on and set the power levels.



This symbol marks the unlock button.



This symbol indicates the direction of rotation of the cutting attachment.

max Ø XXX This icon shows the maximum diameter of the cutting attachment in millimeters.



This symbol shows the rated speed of the cutting attachment.



Guaranteed sound power level in accordance with Directive 2000/14/EC in dB(A) for the purpose of comparing the sound emissions of products.



The battery is equipped with a Bluetooth® radio interface and can be paired with the STIHL connected app.



The information next to the symbol indicates the energy content of the battery according to the cell manufacturer's specification. The energy content available in operation is lower.



Do not dispose of the product with domestic waste.

4 Safety Precautions

4.1 Warning Signs

4.1.1 Warning Symbols

Meanings of warning signs on the brushcutter and battery:



Observe safety notices and take the necessary precautions.



Read, understand and keep the instruction manual.



Wear safety glasses. If objects are likely to fall while working: wear a hard hat.



Wear safety boots.



Wear work gloves.



Observe the safety notices on kickback and take the necessary precautions.



Observe the safety advice concerning flying objects and associated measures.



Maintain a safety distance.



Remove the battery during work stoppages, transport, storage, maintenance or repair.



Do not touch hot surface.



Protect battery from heat and fire.



Do not immerse battery in fluids.



Observe the permitted battery temperature range.

4.1.2 Deflector for mowing heads

Meanings of warning signs and labels on the deflector for mowing heads:



Use this deflector for mowing heads.



Do not use this deflector for grass cutting blades.



Do not use this deflector for brush knives.



Do not use this deflector for shredder blades.



Do not use this deflector for circular saw blades.

4.1.3 Universal Deflector and Skirt

Universal deflector

Meanings of warning signs on the universal deflector:



Do not use this deflector without skirt for mowing heads.



Use this deflector for grass cutting blades.



Use use this deflector for brush knives.



Use this deflector for shredder blades.



Do not use this deflector for circular saw blades.

Skirt

Meanings of warning signs on the skirt:



Use the universal deflector with skirt and line limiting blade for mowing heads.

4.2 Intended Use

The STIHL FSA 135 brushcutter is designed for the following applications:

- With a mowing head: mowing grass
- With a grass cutting blade: mowing grass and weeds
- with a brush knife: Cutting brush with a stem diameter up to 20 mm
- with a circular saw blade: For cutting shrubs and trees with a stem diameter up to 40 mm

The brushcutter may be used in the rain.

The brushcutter is powered by a STIHL AP battery or a STIHL AR battery.

The battery with  in combination with the STIHL connected app enables customization and the transfer of information to the battery using Bluetooth® technology.

WARNING

- Batteries not explicitly approved for the brushcutter by STIHL may cause a fire or an explosion. Persons may be seriously or fatally injured, and property may be damaged.
 - ▶ Use the brushcutter with a STIHL AP battery or a STIHL AR battery.
- Using the brushcutter or the battery for purposes for which they were not designed may result in serious or fatal injuries and damage to property.
 - ▶ Use the brushcutter as described in this User Manual.
 - ▶ Use the battery as described in this User Manual, the STIHL AR battery User Manual, the STIHL connected app and at www.connect.stihl.com.

4.3 The Operator

WARNING

- Users without adequate training or instruction cannot recognize or assess the risks involved in using the trimmer and battery. The user or other persons may sustain serious or fatal injuries.



- ▶ Read, understand and save the instruction manual.

- ▶ If the trimmer or battery are passed on to another person: Always give them the instruction manual.
- ▶ Make sure the user meets the following requirements:
 - The user must be rested.
 - The user must be in good physical condition and mental health to operate and work with the trimmer and battery. If the user's physical, sensory or mental ability is restricted, he or she may work only under the supervision of or as instructed by a responsible person.
 - The user is able to recognize and assess the risks involved in using the trimmer and battery.
 - The user must be of legal age or is being trained in a trade under supervi-

sion in accordance with national rules and regulations.

- The user has received instruction from a STIHL servicing dealer or other experienced user before working with the trimmer for the first time.
 - The user must not be under the influence of alcohol, medication or drugs.
- ▶ If you have any queries: Contact a STIHL servicing dealer for assistance.

4.4 Clothing and equipment

WARNING

- Long hair can be drawn into the brushcutter during operation. This may result in serious injury to the user.
 - ▶ Tie up and confine long hair above your shoulders.
- Objects can be thrown at high speed during operation. This may result in injury to the user.



- ▶ Wear close-fitting safety glasses. Suitable safety glasses are tested in accordance with EN 166 or national regulations and available commercially with the corresponding marking.

- ▶ Wear face protection.
- ▶ Wear long trousers made from resistant material.
- Falling objects can cause head injuries.



- ▶ If objects are likely to fall while working: wear a hard hat

- Dust can be whipped up during operation. Whipped up dust can damage the respiratory passages and cause allergic reactions.

- ▶ If dust is generated: Wear a dust respirator mask.

- Inappropriate clothing can snag on wood, brush or the brushcutter. Users not wearing suitable clothing are at risk of serious injury.

- ▶ Wear close-fitting clothing.
- ▶ Remove scarves and jewelry.
- The user may come into contact with the rotating cutting attachment during operation. This may result in serious injury to the user.
- ▶ Wear robust footwear.



- ▶ If you are using a metal cutting attachment: Wear steel-toed safety boots.

- ▶ Wear long trousers made from resistant material.
- There is a risk of the user coming into contact with the cutting attachment or the line limiting

blade during cleaning and maintenance work and when the cutting attachment is mounted or removed. This may result in injury to the user.



- ▶ Wear work gloves made from resistant material.

- Wearing unsuitable footwear may cause the user to slip. This may result in injury to the user.
 - ▶ Wear sturdy, closed-toed footwear with high-grip soles.

4.5 Work Area and Surroundings

4.5.1 Brushcutter

▲ WARNING

- Bystanders, children and animals are not aware of the dangers of the brushcutter or flying debris. This may result in serious injury to bystanders, children and animals and damage to property.



- ▶ Do not allow bystanders, children or animals within 15 meters of the work area.

- ▶ Maintain a clearance of 15 meters from objects.
- ▶ Do not leave the brushcutter unattended.
- ▶ Make sure that children cannot play with the brushcutter.
- Electrical components of the brushcutter can produce sparks. Sparks may cause fires and explosions in highly flammable or explosive environments. Persons may be seriously or fatally injured and property may be damaged.
 - ▶ Do not work in a highly flammable or explosive environment.

4.5.2 Battery

▲ WARNING

- Bystanders, children and animals cannot recognize or assess the dangers of the battery. Bystanders, children and animals may be seriously injured.
 - ▶ Keep bystanders, children and animals away from the work area.
 - ▶ Do not leave the battery unattended.
 - ▶ Make sure that children cannot play with the battery.
- The battery is not protected against all ambient conditions. If the battery is exposed to certain ambient conditions, the battery may catch fire, explode or be irreparably damaged. This

may result in serious injury to people and damage to property.



- ▶ Protect battery from heat and fire.
- ▶ Do not throw the battery into a fire.



- ▶ Use and store the battery at temperatures between - 10 °C and + 50 °C.



- ▶ Do not immerse the battery in fluids.

- ▶ Keep battery away from small metal parts.
- ▶ Do not expose the battery to high pressure.
- ▶ Do not expose the battery to microwaves.
- ▶ Protect the battery from chemicals and salts.

4.6 Safe Condition

4.6.1 Brushcutter

The brushcutter is in a safe condition if the following points are observed:

- The brushcutter is not damaged.
- The brushcutter is clean.
- The controls function properly and have not been modified.
- A combination of cutting attachment and deflector recommended in this user manual is mounted.
- The cutting attachment and deflector are properly mounted.
- Genuine STIHL accessories for this brushcutter are fitted.
- The accessories are correctly attached.

▲ WARNING

- If not in safe condition, components may no longer operate correctly and safety devices may be disabled. This may result in serious or fatal injury to people.
 - ▶ Work only with an undamaged brushcutter.
 - ▶ If the brushcutter is dirty: Clean the brushcutter.
 - ▶ Never attempt to modify your brushcutter. Exception: Mounting one of the combinations of cutting attachment and deflector recommended in this user manual.
 - ▶ If the controls do not function properly: Do not use your brushcutter.
 - ▶ Fit genuine STIHL accessories for this brushcutter.
 - ▶ Mount the cutting attachment and deflector as described in this user manual.

- ▶ Attach accessories as described in this User Manual or in the User Manual for the accessories.
- ▶ Never insert objects in the openings of the brushcutter.
- ▶ Replace worn or damaged labels.
- ▶ If you have any doubts, be sure to consult a STIHL dealer.

4.6.2 Deflector

The deflector is in a safe condition if the following points are observed:

- The deflector is not damaged.
- If you are using the line limiting blade and skirt: Line limiting blade and skirt are correctly fitted.

▲ WARNING

- If components do not comply with safety requirements, they will no longer function properly and safety devices may be rendered inoperative. This can result in serious injuries.
 - ▶ Work only with an undamaged deflector.
 - ▶ If you are using the line limiting blade and skirt: Work with a correctly fitted line limiting blade and skirt.
 - ▶ If you have any queries: Contact your STIHL servicing dealer.

4.6.3 Mowing Head

The mowing head is in a safe condition if the following points are observed:

- The mowing head is not damaged.
- The mowing head is not jammed.
- The mowing lines are properly installed.
- The wear limits are not exceeded.

▲ WARNING

- If they are in an unsafe condition, parts of the mowing head or mowing lines may come off and be ejected at high speed. They may cause serious injury to persons.
 - ▶ Work only with an undamaged mowing head.
 - ▶ Never use metal objects in place of the nylon mowing lines.
 - ▶ Observe and remain inside the wear limits.
 - ▶ If you have any doubts, be sure to consult a STIHL dealer.

4.6.4 Metal cutting attachment

The metal cutting attachment is in a safe condition if the following points are observed:

- Metal cutting attachment and mounting hardware are undamaged.
- Metal cutting attachment is not warped.
- Metal cutting attachment is properly mounted.

- Metal cutting attachment is correctly sharpened.
- Cutting edges of the metal cutting attachment have no burrs.
- The wear limits are not exceeded.
- If a metal cutting attachment not manufactured by STIHL is used, it must not be heavier, thicker, of a different shape, of a lower quality, or larger in diameter than the largest metal cutting attachment approved by STIHL.

▲ WARNING

- If it is not in a safe condition, parts of the metal cutting attachment may come off and be thrown at high speed. They may cause serious injury to persons.
 - ▶ Never work with a damaged metal cutting attachment or damaged mounting hardware.
 - ▶ Sharpen the metal cutting attachment correctly.
 - ▶ Deburr the cutting edges with a file.
 - ▶ Have the metal cutting attachment balanced by a STIHL servicing dealer.
 - ▶ Observe and remain inside the wear limits.
 - ▶ Use a metal cutting attachment specified in these instructions for use.
 - ▶ If you have any doubts, be sure to consult a STIHL dealer.

4.6.5 Battery

The battery is in safe condition when the following conditions are met:

- The battery is not damaged.
- The battery is clean and dry.
- The battery is working and has not been modified.

▲ WARNING

- The battery cannot function safely if it is not in safe condition. There is a risk of serious injury to persons.
 - ▶ Use an undamaged and functioning battery.
 - ▶ Do not charge a damaged or defective battery.
 - ▶ If the battery is dirty or wet: clean the battery and allow it to dry.
 - ▶ Do not modify the battery.
 - ▶ Do not insert objects into the apertures in the battery.
 - ▶ Never connect the battery terminals to metallic objects and cause a short circuit.
 - ▶ Do not open the battery.
 - ▶ Replace worn or damaged warning signs.

- Fluid may leak from a damaged battery. If the fluid contacts the skin or eyes, this may cause irritation.
 - ▶ Avoid contact with the fluid.
 - ▶ In the event of contact with the skin: wash the affected areas with plenty of soap and water.
 - ▶ In the event of contact with the eyes: rinse the eyes with plenty of water for at least 15 minutes and seek medical attention.
- A damaged or defective battery may emit an unusual odour, smoke or catch fire. This may result in serious or fatal injury to people and damage to property.
 - ▶ If the battery emits an unusual odour or smoke: do not use the battery and keep it away from flammable materials.
 - ▶ If the battery catches fire: try to extinguish the battery using a fire extinguisher or water.

4.7 Working

▲ WARNING

- In certain situations, the user may no longer be able to concentrate on their work. This may result in the user stumbling, falling and suffering serious injury.
 - ▶ Work calmly and in a considered manner.
 - ▶ If light and visibility are poor: Do not use your trimmer.
 - ▶ Operate the trimmer alone.
 - ▶ Keep the cutting attachment close to the ground.
 - ▶ Watch out for obstacles.
 - ▶ Work standing on the ground and keep your balance.
 - ▶ If you feel tired, take a break.
- The rotating cutting attachment can cut the user. This may result in serious injury to the user.
 - ▶ Do not touch the rotating cutting attachment.
 - ▶ If the cutting attachment is blocked by an object: Switch off the brushcutter and remove the battery. Only then should you remove the object.
- If the behavior of the trimmer changes during operation or feels unusual, it may no longer be in a safe condition. There is a risk of serious injury to people and damage to property.
 - ▶ Stop working, remove the battery and consult a STIHL dealer.
- Vibrations may occur during trimmer operation.



- ▶ Wear gloves.

- ▶ Take breaks.
- ▶ If signs of a circulatory disturbance occur: Consult a doctor.
- If the cutting attachment makes contact with a foreign object during operation, the object or parts of it may be thrown at high speed. Persons may be injured or property damaged.
 - ▶ Remove foreign objects from the working area.
- If the rotating cutting attachment makes contact with a hard object, sparks may occur and the cutting attachment may be damaged. Sparks can cause fires in a flammable environment. Persons may be seriously or fatally injured and property may be damaged.
 - ▶ Do not use in a flammable environment.
 - ▶ Make sure the cutting attachment is in a safe condition.
- Note that the cutting attachment continues to rotate for a short period after you release the trigger. They may cause serious injury to persons.
 - ▶ Wait until the cutting attachment comes to a complete stop.
- In an emergency, the user may start to panic and forget to take off the carrying system. This may result in serious injury to the user.
 - ▶ Practice taking off the carrying system.

4.8 Reactive Forces

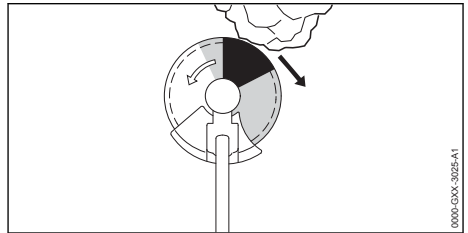

Kickout can be caused for the following reasons:

- The shaded area or the black area of the rotating metal cutting attachment comes into contact with a solid object and is suddenly braked.
- The rotating metal cutting attachment gets pinched in the cut.

The risk of kickout is greatest in the black area.

▲ WARNING

- These situations can abruptly decelerate or stop rotation of the cutting attachment and cause the cutting attachment to be thrown to

the right or in the direction of the user (black arrow). The user can lose control of the trimmer. This can result in serious or fatal injuries.

- ▶ Hold the trimmer firmly with both hands.
- ▶ Use the working techniques described in this instruction manual.
- ▶ Do not use the black area for cutting.
- ▶ Use a combination of cutting attachment, deflector and carrying system recommended in this instruction manual.
- ▶ Sharpen the metal cutting attachment correctly.
- ▶ Cut with the motor running at full speed.

4.9 Transporting

4.9.1 Brushcutter

⚠ WARNING

- The gear housing can get hot during operation. There is a risk of burn injuries.
 - ▶ Do not touch a hot gear housing.



- The brushcutter may tilt over or shift during transport. Persons may be injured or property damaged.



- ▶ Remove the battery.
 - ▶ If a metal cutting attachment is mounted: Fit the transport guard.
 - ▶ Secure the brushcutter with lashing straps, belts or a net to prevent it turning over and moving.

4.9.2 Battery

⚠ WARNING

- The battery is not protected against all ambient conditions. The battery may be damaged if it is exposed to certain ambient conditions, and damage to property may occur.
 - ▶ Never transport a damaged battery.
- The battery may turn over or shift during transport. This may result in injury to people and damage to property.
 - ▶ Pack the battery in packaging in such a way that it cannot move.
 - ▶ Secure the packaging so that it cannot move.

4.10 Storing

4.10.1 Brushcutter

⚠ WARNING

- Children are not aware of and cannot assess the dangers of a brushcutter and can be seriously injured.



- ▶ Remove the battery.
 - ▶ If a metal cutting attachment is mounted: Fit the transport guard.
 - ▶ Store the brushcutter out of the reach of children.
- Dampness can corrode the electrical contacts on the brushcutter and metal components. This can damage the brushcutter.
 - ▶ Remove the battery.



- ▶ Store the brushcutter in a clean and dry condition.

4.10.2 Battery

⚠ WARNING

- Children are not aware of and cannot assess the dangers of the battery. Children may be seriously injured.
 - ▶ Store the battery out of the reach of children.
- The battery is not protected against all ambient conditions. If the battery is exposed to certain ambient conditions, the battery may be irreparably damaged.
 - ▶ Store the battery in a clean and dry condition.
 - ▶ Store the battery in an enclosed space.
 - ▶ Store the battery separately from the brushcutter.
 - ▶ If the battery is stored in the charger, disconnect the mains plug and store the rechargeable battery at a battery charge status between 40% and 60% (2 lit green LEDs).
 - ▶ Store the battery at a temperature range between - 10 °C and + 50 °C.

4.11 Cleaning, Maintenance and Repair

⚠ WARNING

- The brushcutter may start up unintentionally if the battery is left in place during cleaning, maintenance or repair operations. This may result in serious injury to people and damage to property.



- ▶ Remove the battery.

- The gear housing can get hot during operation. There is a risk of burn injuries.



- ▶ Do not touch a hot gear housing.

- Aggressive cleaning agents, a water jet or pointed objects can damage the trimmer, deflector, cutting attachment or battery. If the brushcutter, deflector, cutting attachment or battery are not cleaned correctly, components may no longer function properly or safety devices may be rendered inoperative. They may cause serious injury to persons.

- ▶ Clean the brushcutter, deflector, cutting attachment and battery as described in this User Manual.

- If the brushcutter, deflector, cutting attachment or battery are not serviced or repaired correctly, components may no longer function properly or safety devices may be rendered inoperative. This may result in serious or fatal injury to people.

- ▶ Do not attempt to service or repair the brushcutter, deflector or battery yourself.
- ▶ If the brushcutter, the deflector or the battery require servicing or repairs, contact your STIHL dealer for assistance.
- ▶ Maintain the cutting attachment as described in the User Manual supplied with the cutting attachment being used or on the cutting attachment's packaging.

- The user can be cut by the sharp cutting edges while cleaning or maintaining cutting attachments. This may result in injury to the user.



- ▶ Wear work gloves made from resistant material.

5 Preparing Trimmer for Operation

5.1 Preparing the Brushcutter for Operation

The following steps must be performed before commencing work:

- ▶ Ensure that the following components are in a safe condition:
 - Brushcutter, [11](#) 4.6.1.
 - Deflector, [11](#) 4.6.2.
 - Mowing head or metal cutting attachment, [11](#) 4.6.3 or [11](#) 4.6.4.
 - Battery, [11](#) 4.6.5.
- ▶ Check the battery, [11](#) 12.2.
- ▶ Fully charge battery as described in the User Manual for the STIHL AL 101, 301, 301-4, 500 chargers.
- ▶ Clean the brushcutter, [11](#) 17.1.
- ▶ Mount the bike handle, [11](#) 8.1.
- ▶ Select combination of cutting attachment, deflector and carrying system, [11](#) 22.
- ▶ Mount the deflector, [11](#) 8.2.1.
- ▶ If you are using a universal deflector together with a mowing head: Fit the skirt and line limiting blade, [11](#) 8.3.1.
- ▶ Mount mowing head or metal cutting attachment, [11](#) 8.4.1 or [11](#) 8.5.1.
- ▶ Fit and adjust the carrying system, [11](#) 9.1.
- ▶ Adjust the bike handle, [11](#) 9.2.
- ▶ Balance the brushcutter, [11](#) 9.3.
- ▶ Check the controls, [11](#) 12.1.
- ▶ If you cannot carry out this work: Do not use your brushcutter and contact your STIHL authorized dealer for assistance.

5.2 Connecting a battery with Bluetooth® radio interface with the STIHL connected app

- ▶ Activate the Bluetooth® radio interface on the mobile device.
- ▶ Activating the Bluetooth® radio interface on the battery, [11](#) 7.1.
- ▶ Download the STIHL connected app to the mobile device from the App Store and create an account.
- ▶ Open and sign in to the STIHL connected app.
- ▶ Add the battery in the STIHL connected app and follow the instructions on the screen.

For contacts and other information, please visit <https://support.stihl.com> or see the STIHL connected app.

The STIHL connected app is available internationally.

6 Charging the Battery, LEDs

6.1 Charging the Battery

The charging time depends on various factors, e.g. the battery temperature or the ambient temperature. The actual charging time may vary from the charging time indicated. The charging time is indicated at www.stihl.com/charging-times.

- ▶ Recharge the battery as described in the User Manual for the STIHL AL 101, 301, 301-4, 500 chargers.

6.2 Displaying the charge level

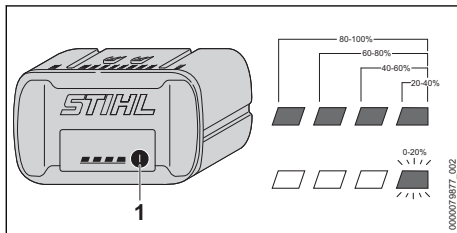

- ▶ Press the button (1).
The LEDs light up green for about 5 seconds and indicate the state of charge.
- ▶ If the LED on the right flashes green: Charge the battery.

6.3 LEDs on Battery

The LEDs can show the state of charge or malfunctions. The LEDs can glow or flash green or red.

The state of charge is indicated when the LEDs glow or flash green.

- ▶ If the LEDs glow or flash red: Troubleshooting, [20](#).
Malfunction in trimmer or battery.

7 Activating and Deactivating Bluetooth® Radio Interface

7.1 Activating the Bluetooth® Radio Interface

- ▶ If the battery has a Bluetooth® radio interface: Press and hold the pushbutton until the "BLUETOOTH®" LED next to the symbol lights up blue for approximately 3 seconds. The Bluetooth® radio interface on the battery is activated.

7.2 Deactivating the Bluetooth® Radio Interface

- ▶ If the battery has a Bluetooth® radio interface: Press and hold the pushbutton until the "BLUETOOTH®" LED next to the symbol lights up blue six times. The Bluetooth® radio interface on the battery is deactivated.

8 Assembling the Trimmer

8.1 Mounting the Bike Handle

- ▶ Switch off the brushcutter and remove the battery.

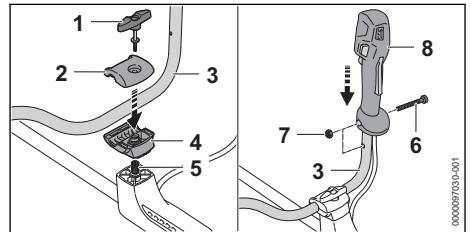

- ▶ Remove the wing screw (1).
- ▶ Remove the clamp moldings (2 and 4).
- ▶ Place the handlebar (3) in the lower clamp molding (4).
- ▶ Fit the upper clamp molding (2).
- ▶ Insert the spring (5) from below into the lower clamp molding (4).
- ▶ Place the clamp moldings (2 and 4) on the shaft and insert the wing screw (1).
- ▶ Swing the handlebar (3) up.
- ▶ Tighten down the wing screw (1).
- ▶ Remove the screw (6).
- ▶ Position the control handle (7) on the handlebar (3), trigger facing the gear housing, and line up the hole in the control handle with the hole in the handlebar.
- ▶ Fit the nut (7).
- ▶ Insert and tighten down the screw (6) firmly.

The bike handle can be left on the shaft.

8.2 Mounting and Removing the Deflector

8.2.1 Mounting the guard

- ▶ Switch off the brushcutter and remove the battery.

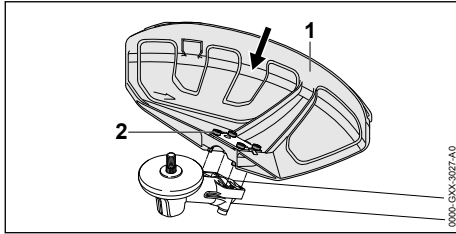

- ▶ Push the deflector (1) into the guides on the gear housing up to the limit stop.
- ▶ Insert the screws (2) and tighten them firmly.

8.2.2 Removing the Deflector

- ▶ Switch off the brushcutter and remove the battery.

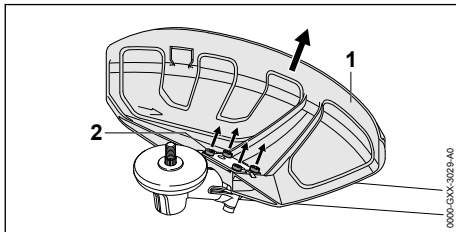

- ▶ Unscrew the screws (2).
- ▶ Pull off the deflector (1).

8.3 Fitting and Removing the Skirt

8.3.1 Fitting the Skirt

- ▶ Switch off the brushcutter and remove the battery.

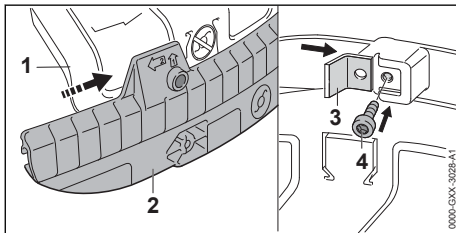

- ▶ Slide the guide slot in the skirt (2) onto the universal deflector (1) – it must snap into position.
- ▶ Push the line limiting blade (3) into the slot in the skirt (2).
- ▶ Insert and tighten down the screw (4) firmly.

8.3.2 Removing the Skirt

- ▶ Switch off the brushcutter and remove the battery.

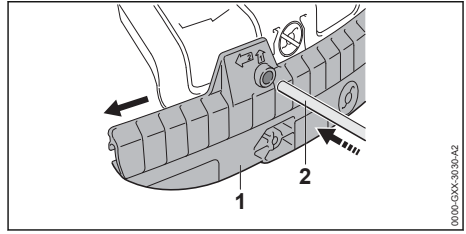

- ▶ Insert the stop pin (2) into the hole in the skirt (1).
- ▶ Remove the skirt (1) with the stop pin (2).

The line limiting blade (1) can be left on the skirt.

8.4 Mounting and Removing the Mowing Head

8.4.1 Mounting the Mowing Head

- ▶ Switch off the brushcutter and remove the battery.

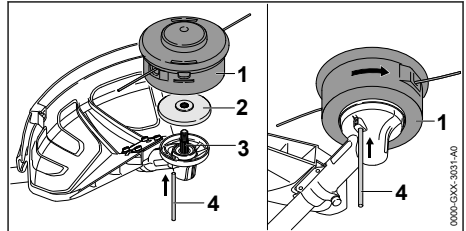

- ▶ Place the thrust plate (2) on the shaft (3) so that its smaller diameter faces up.
- ▶ Fit the mowing head (1) on the shaft (3) and turn it counterclockwise by hand.
- ▶ Insert the stop pin (4) in the bore up to the limit stop and hold it depressed.
- ▶ Turn the mowing head (1) counterclockwise until the stop pin (4) engages in position. The shaft (3) is now blocked.
- ▶ Tighten down the mowing head (1) firmly by hand.
- ▶ Remove the stop pin (4).

8.4.2 Removing the Mowing Head

- ▶ Switch off the brushcutter and remove the battery.
- ▶ Insert the stop pin in the bore up to the limit stop and hold it depressed.
- ▶ Rotate the mowing head until the stop pin engages in position. The shaft is now blocked.
- ▶ Unscrew the mowing head clockwise.
- ▶ Remove the thrust plate.
- ▶ Remove the stop pin.

8.5 Removing and Installing Metal Cutting Attachment

8.5.1 Mounting the Metal Cutting Attachment

- ▶ Switch off the brushcutter and remove the battery.

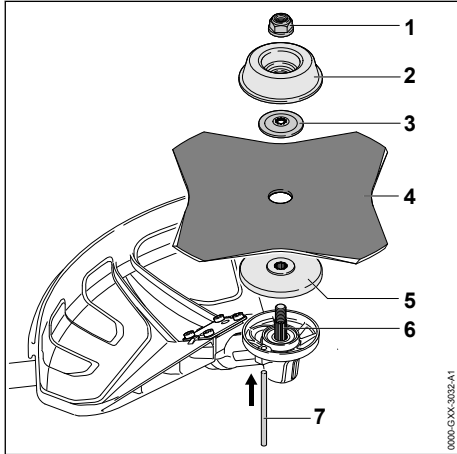

- ▶ Place the thrust plate (5) on the shaft (6) so that its smaller diameter faces up.
- ▶ Place the metal cutting attachment (4) on the thrust plate (5). If you are fitting a circular saw blade or a grass cutting blade with more than 4 cutting edges: Its cutting edges must face in the same direction as the arrow on the deflector.
- ▶ Place the thrust washer (3) on the metal cutting attachment (4) so that its raised side faces up.
- ▶ Place the rider plate (2) on the thrust washer (3) so that its closed side faces up.
- ▶ Insert the stop pin (7) in the bore up to the limit stop and hold it depressed.
- ▶ Rotate the metal cutting attachment (4) counterclockwise until the stop pin (7) engages in position. The shaft (6) is now blocked.
- ▶ Fit the nut (1) counterclockwise and tighten it down firmly.
- ▶ Remove the stop pin (7).

8.5.2 Removing the metal cutting attachment

- ▶ Switch off the brushcutter and remove the battery.
- ▶ Insert the stop pin in the bore up to the limit stop and hold it depressed.

- ▶ Rotate the metal cutting attachment clockwise until the stop pin engages in position. The shaft is now blocked.
- ▶ Unscrew the mounting nut clockwise.
- ▶ Remove the rider plate, thrust washer, metal cutting attachment and thrust plate.
- ▶ Remove the stop pin.

9 Adjusting Trimmer for User

9.1 Fitting and Adjusting the Carrying System

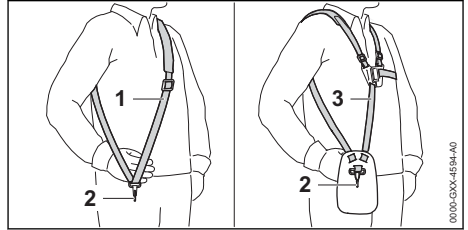

- ▶ Put on the shoulder strap (1) or full harness (3).
- ▶ Adjust the shoulder strap (1) or full harness (3) so that the carabiner (2) is about a hand's width below your right hip.

Other approved carrying systems are listed in this User Manual, [12](#) 22.

9.2 Adjusting the Bike Handle

The bike handle can be set to different positions to suit the height and reach of the user.

- ▶ Switch off the brushcutter and remove the battery.
- ▶ Hook the brushcutter from the carrying strip into the carabiner of the carrying system.

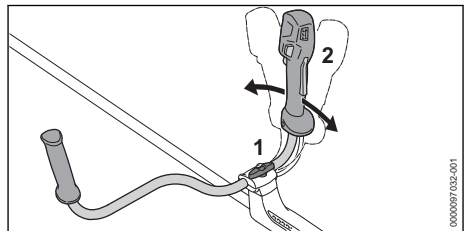

- ▶ Loosen the wing screw (1).
- ▶ Swing the bike handle (2) to the required position.
- ▶ Tighten down the wing screw (1) firmly.

9.3 Balancing the Brushcutter

- ▶ Switch off the brushcutter and remove the battery.

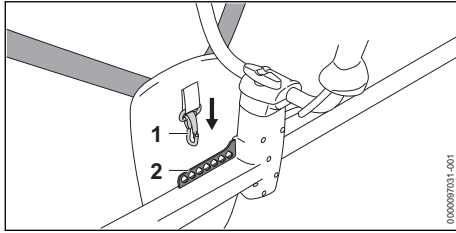

- ▶ Hook the carrying strip (2) onto the carabiner (1).

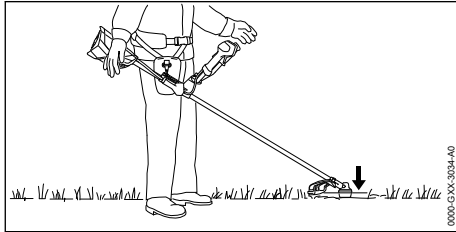

- ▶ Let go of the brushcutter and check to see how it is balanced - the cutting attachment should just rest on the ground.
- ▶ If the brushcutter cannot be balanced: Change the attachment point of the carabiner (1) on the carrying strip (2) and check the balance again.

10 Removing and Fitting the Battery

10.1 Inserting the Battery

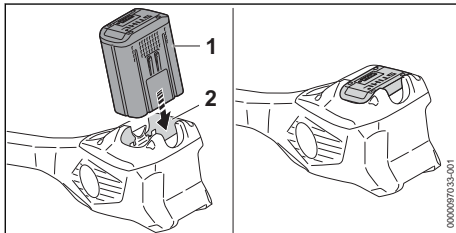

- ▶ Insert the battery (1) up to the limit stop into the battery compartment (2). The battery (1) engages with a click and is now locked.

10.2 Removing the Battery

- ▶ Set the brushcutter on a level surface.

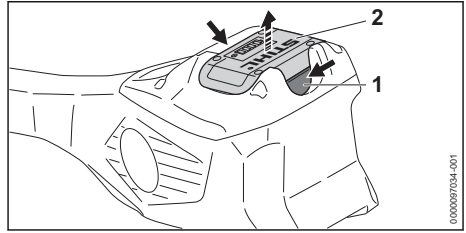

- ▶ Press both locking levers (1). The battery (2) is released and can be removed.

11 Switching the Trimmer On/Off

11.1 Switching the Brushcutter on

- ▶ Hold the brushcutter firmly with your right hand on the control handle – wrap your thumb around the handle.
- ▶ Hold the brushcutter with your the left hand on the left grip in such a way that your thumb encloses the handle.

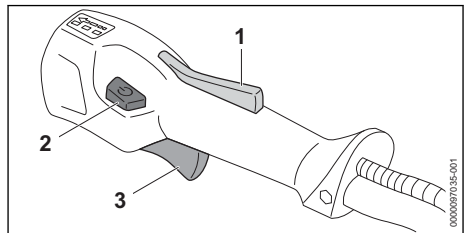

- ▶ Press the trigger lockout (1) with your hand and keep it pressed.
- ▶ Press the unlock button (2). The LEDs emit light to indicate the power level used last.
- ▶ Squeeze and hold the trigger (3) with your index finger. The brushcutter accelerates and the cutting attachment rotates.

The further the trigger (3) is depressed, the faster the rotation of the cutting attachment.

The brushcutter can also be switched on by first pressing the release button (2) and pressing the trigger lockout (1) within 5 seconds (as long as the LEDs are flashing). The trigger (3) is now unlocked and the brushcutter is ready for use.

At power level 3, the brushcutter identifies the cutting attachment used and automatically sets the maximum speed.

The LEDs continue flashing for 5 seconds after the trigger (3) and trigger lockout (1) are released after switch-on. As long as the LEDs are flashing, the brushcutter can be switched on again without having to operate the unlock button (2).

11.2 Switching Off

- ▶ Release the trigger and lockout lever at the same time.
- ▶ Wait for the cutting attachment to come to a standstill.
- ▶ If the cutting attachment continues to rotate: Remove the battery and contact your STIHL servicing dealer. The trimmer has a malfunction.

12 Testing the Trimmer and Battery

12.1 Checking the controls

Trigger lockout and trigger

- ▶ Remove the battery.
- ▶ Try pressing the trigger without pressing the trigger lockout.
- ▶ If you can press the trigger: Stop using your brushcutter and contact a STIHL dealer. The trigger lockout is faulty.
- ▶ Press and hold the trigger lockout.
- ▶ Squeeze and release the trigger.
- ▶ If the trigger or trigger lockout is stiff or does not spring back to the idle position: Do not use your brushcutter and contact your STIHL dealer for assistance. The trigger or the trigger lockout is defective.

Switching the Brushcutter on

- ▶ Insert battery.
- ▶ Press and hold the trigger lockout.
- ▶ Press the unlock button.
- ▶ Press and hold the trigger. The cutting attachment rotates.
- ▶ If 3 LEDs on the battery flash red: Remove the battery and contact your STIHL dealer for assistance. The brushcutter has a malfunction.
- ▶ Release the trigger. The cutting attachment stops rotating after a brief delay.
- ▶ If the cutting attachment continues to rotate: Remove the battery and contact your STIHL dealer. The brushcutter is defective.

12.2 Testing the Battery

- ▶ Press button on battery. The LEDs glow or flash.
- ▶ If the LEDs do not glow or flash: Do not use the battery and contact your STIHL servicing dealer. There is a malfunction in the battery.

13 Operating the Trimmer

13.1 Holding and Controlling the Brushcutter

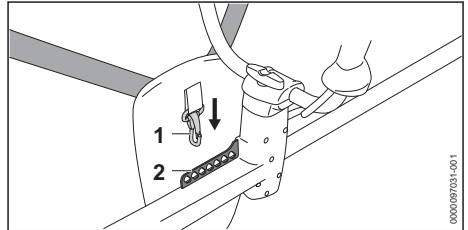

- ▶ Hook the carrying strip (2) onto the carabiner (1).

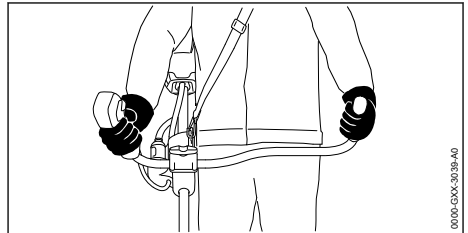

- ▶ Hold the brushcutter firmly with your right hand on the control handle – wrap your thumb around the handle.
- ▶ Hold the brushcutter with your left hand on the left grip in such a way that your thumb encloses the handle.

13.2 Setting the performance level

Depending on the application, 3 power levels can be set. The LEDs indicate the selected power level. The higher the power level, the faster the cutting attachment can run.

The selected power level affects the battery's runtime. The lower the power level, the longer the runtime.

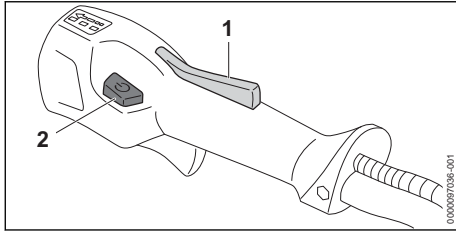

- ▶ Press and hold the trigger lockout (1).
- ▶ Press the unlock button (2).
The LEDs emit light to indicate the power level selected.
- ▶ Press and hold the unlock button (2).
This selects the next power level. After the third performance level, it starts again with the first performance level.
- ▶ Push the unlock button (2) as many times as necessary to set the desired power level.
- ▶ If you are using a circular saw blade: Select power level 3.

13.3 Mowing

The cutting height is determined by the distance of the cutting attachment from the ground.

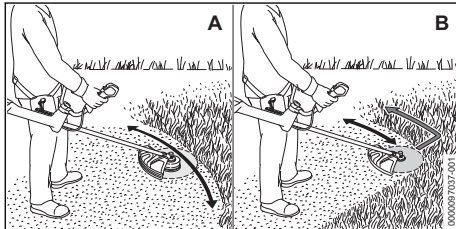

Mowing with a mowing head (A)

- ▶ Swing the brushcutter steadily back and forth in an arc.
- ▶ Move forward slowly in a controlled manner.

Mowing with a grass cutting blade or brush knife (B)

- ▶ Mow with the left-hand side on the metal cutting attachment.
- ▶ Move forward slowly in a controlled manner.

13.4 Saws with a circular saw blade

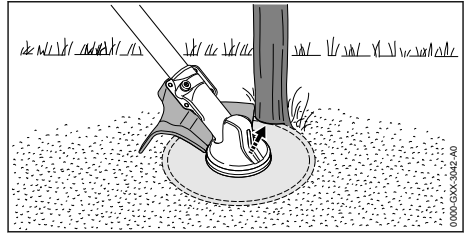

- ▶ Support the left side of the deflector against the stem.
- ▶ Cut through the stem at full speed.
- ▶ A safety distance of at least 2 tree lengths to the next work area.

13.5 Adjusting Nylon Line

13.5.1 Line Feed on AutoCut Mowing Heads

- ▶ Briefly tap the rotating mowing head on the ground.
About 30 mm of fresh nylon line is advanced.
The line limiting blade in the deflector automatically cuts the mowing lines to the correct length.

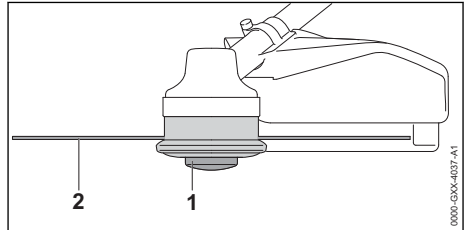

Automatic feed will not take place if the mowing lines are shorter than 25 mm.

- ▶ Switch off the brushcutter and remove the battery.
- ▶ Depress the spool (1) on the mowing head and hold it depressed.
- ▶ Pull out the mowing lines (2) by hand.
- ▶ If the mowing lines (2) cannot be pulled out to the required length: Replace the spool (1) or the mowing lines (2).
The spool is empty.

13.5.2 Line Feed on SuperCut Mowing Heads

Mowing lines are advanced automatically. The line limiting blade in the deflector automatically cuts the mowing lines to the correct length.

Automatic feed will not take place if the mowing lines are shorter than 40 mm.

- ▶ Switch off the brushcutter and remove the battery.
- ▶ Pull out the mowing lines by hand.
- ▶ If the mowing lines cannot be pulled out to required length: Replace the mowing lines. The spool is empty.

14 After Finishing Work

14.1 When Work is Finished

- ▶ Switch off the brushcutter and remove the battery.
- ▶ If the brushcutter is wet: Allow the brushcutter to dry.
- ▶ If the battery is wet: Allow the battery to dry.
- ▶ Clean the brushcutter.
- ▶ Clean the deflector.
- ▶ Clean the cutting attachment.
- ▶ Clean battery.
- ▶ If a metal cutting attachment is mounted: Fit the matching transport guard.

15 Transporting

15.1 Transporting the brushcutter

- ▶ Switch off the brushcutter and remove the battery.
- ▶ If a metal cutting attachment is mounted: Fit the matching transport guard.

Carrying the brushcutter

- ▶ Carry the brushcutter in one hand properly balanced by the shaft, with the cutting attachment behind you.

Transporting the brushcutter in the car

- ▶ Secure the brushcutter to prevent turnover and movement.

15.2 Transporting the Battery

- ▶ Switch off the brushcutter and remove the battery.
- ▶ Check that the battery is in a safe condition.
- ▶ Pack the battery in packaging in such a way that it cannot move inside the packaging.
- ▶ Secure the packaging so that it cannot move.

The battery is subject to the Carriage of Dangerous Goods regulations. The battery is classified as UN 3480 (lithium ion batteries) and has been tested pursuant to UN Manual Tests and Criteria Part III, Subsection 38.3.

The transport regulations can be found at www.stihl.com/safety-data-sheets.

16 Storing

16.1 Storing the Brushcutter

- ▶ Switch off the brushcutter and remove the battery.
- ▶ If a metal cutting attachment is mounted: Fit the appropriate transport guard.

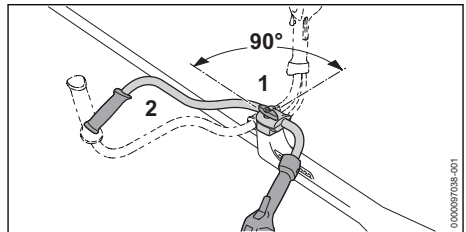

- ▶ Loosen the wing screw (1) and unscrew it until the handlebar (2) can be rotated.
- ▶ Turn the handlebar (2) clockwise through 90° and fold it down.
- ▶ Tighten down the wing screw (1) firmly.
- ▶ Ensure that the following conditions are met when storing the brushcutter:
 - The brushcutter is out of the reach of children.
 - The brushcutter is clean and dry.
- ▶ If you store the brushcutter for more than 30 days: Remove the cutting attachment.

16.2 Storing the Battery

STIHL recommends keeping the battery in a charging state between 40% and 60 % (2 green LEDs lit).

- ▶ The battery should be stored in such a way that the following conditions are fulfilled:
 - The battery is out of the reach of children.
 - The battery is clean and dry.
 - The battery is in an enclosed space.
 - The battery is separated from the brushcutter.
 - If the battery is stored in the charger, disconnect the mains plug and store the rechargeable battery at a battery charge status between 40 % and 60 % (2 lit green LEDs).
 - The battery is in a temperature range between - 10 °C and + 50 °C.

NOTICE

- If the battery is not stored as described in this user manual, the battery may become deeply discharged and irreparably damaged.
 - ▶ Charge a discharged battery before storing it. STIHL recommends keeping the battery in a charging state between 40% and 60% (2 lit green LEDs).
 - ▶ Store the battery separately from the brushcutter.

17 Cleaning**17.1 Cleaning the Brushcutter**

- ▶ Switch off the brushcutter and remove the battery.
- ▶ Clean the brushcutter with a damp cloth.
- ▶ Clean vents with a paintbrush.
- ▶ Remove foreign objects from the battery compartment and clean the battery compartment with a damp cloth.
- ▶ Clean the electrical contacts in the battery compartment with a paintbrush or soft brush.

17.2 Cleaning the Deflector and Cutting Attachment

- ▶ Switch off the trimmer and remove the battery.
- ▶ Clean the deflector and cutting attachment with a damp cloth or a soft brush.

17.3 Cleaning the Air Filter

- ▶ Switch off the brushcutter and remove the battery.

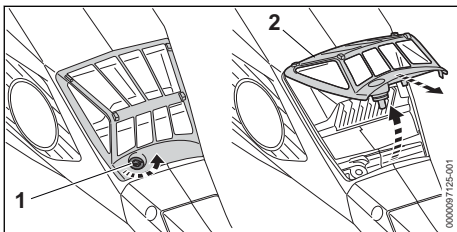

- ▶ Clean the area around the air filter (2) with a damp cloth or a soft brush.
- ▶ Turn the screw (1) counterclockwise until the air filter (2) can be removed.
- ▶ Swing the air filter (2) upwards and pull it off.
- ▶ Pass the air filter (2) under running water to rinse off coarse dirt from the outside.
- ▶ If the air filter (2) is damaged: Install a new air filter (2).
- ▶ Allow the air filter (2) to dry in the air.

- ▶ Install the air filter (2) in the housing and fold it down.
 - The air filter (2) must sit flush in the housing at all sides.
- ▶ Insert and tighten down the screw (1) firmly.

17.4 Cleaning the Battery

- ▶ Clean the battery with a damp cloth.

18 Maintenance**18.1 Maintenance intervals**

Maintenance intervals depend on the ambient conditions and the operating conditions. STIHL recommends the following maintenance intervals:

After every 50 hours of operation

- ▶ Lubricate the gearbox.
- ▶ Clean the air filter.

Annually

- ▶ Have the brushcutter checked by a STIHL dealer.

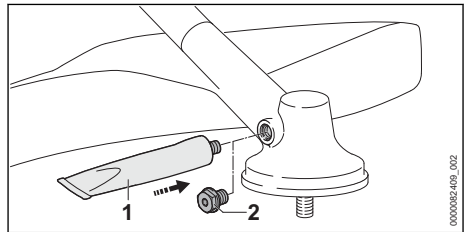
18.2 Lubricating the gearbox

- ▶ Remove screw plug (2).
- ▶ If no grease can be seen on the end of the screw plug (2):
 - ▶ Screw in the tube of STIHL gear lubricant (1).
 - ▶ Squeeze 5 g of STIHL gear grease into the gear housing.
 - ▶ Unscrew the tube of STIHL gear lubricant (1).
 - ▶ Refit and firmly tighten the screw plug (2).
 - ▶ Run the brushcutter for 1 minute without load.
 - The STIHL gear lubricant is evenly distributed.

18.3 Sharpening and Balancing a Metal Cutting Attachment

Correctly sharpening and balancing metal cutting attachments requires a lot of practice.

STIHL recommends you have metal cutting attachments resharpened and balanced by a STIHL servicing dealer.

- ▶ Sharpen the metal cutting attachment as described in the instructions and on the packaging supplied with the cutting attachment you are using.

19 Repairing

19.1 Repairing the Trimmer and Cutting Attachment

The trimmer and cutting attachment cannot be repaired by the user.

- ▶ If the trimmer or cutting attachment is damaged: Do not use your trimmer or cutting

20 Troubleshooting

20.1 Troubleshooting the Brushcutter or Battery



Fault	LEDs on the battery	Cause	Remedy
The brushcutter does not start when switched on.	1 LED flashing green.	State of charge of the battery is too low.	▶ Recharge the battery fully as described in the User Manual for the STIHL AL 101, 301, 301-4, 500 chargers.
	1 LED emits red light.	The battery is too warm or too cold.	▶ Remove the battery. ▶ Allow the battery to cool down or warm up.
	3 LEDs flash red.	The brushcutter has a malfunction.	▶ Remove the battery. ▶ Clean electrical contacts in the battery compartment. ▶ Insert battery. ▶ Switch on the brushcutter. ▶ If 3 LEDs continue to flash red: Do not use your brushcutter and contact your STIHL dealer for assistance.
	3 LEDs light up red.	Trimmer is too hot.	▶ Remove the battery. ▶ Allow trimmer to cool down.
	4 LEDs flash red.	There is a fault in the battery.	▶ Remove battery and reinsert it. ▶ Switch on the brushcutter. ▶ If 4 LEDs continue to flash red: Do not use the battery; contact a STIHL authorized dealer.
		No electrical contact between brushcutter and battery.	▶ Remove the battery. ▶ Clean electrical contacts in the battery compartment. ▶ Insert battery.
		The brushcutter or battery is damp.	▶ Allow the brushcutter or battery to dry.
		Trigger is pressed before operating the unlock button.	▶ Switch on the brushcutter as described in this User Manual.
The brushcutter cuts out during operation.	3 LEDs light up red.	Trimmer is too hot.	▶ Remove the battery. ▶ Allow trimmer to cool down.

attachment and contact your STIHL servicing dealer.

19.2 Servicing and Repairing the Battery

The battery requires no servicing and cannot be repaired.

- ▶ If the battery has a malfunction or is damaged: Replace the battery.

Fault	LEDs on the battery	Cause	Remedy
		There is an electrical fault.	<ul style="list-style-type: none"> ▶ Remove battery and reinsert it. ▶ Switch on the brushcutter.
The runtime of the brushcutter is too short.		The battery is not fully charged.	▶ Recharge the battery fully as described in the User Manual for the STIHL AL 101, 301, 301-4, 500 chargers.
		The battery life has been exceeded.	▶ Replace battery.
The power levels cannot be set.		The trigger is depressed and the brushcutter switched on.	<ul style="list-style-type: none"> ▶ Release the trigger and hold only the trigger lockout pressed. ▶ Select the power level as described in this User Manual.
STIHL connected app is unable to find the battery with  .		Bluetooth® radio interface on the battery or mobile device is deactivated.	▶ Activate Bluetooth® radio interface on the battery or mobile device.
		Distance between battery and mobile device is too long.	<ul style="list-style-type: none"> ▶ Reduce distance,  21.2. ▶ If the battery still cannot be found with the STIHL connected app: Contact a STIHL authorized dealer for assistance.

20.2 Product Support and Assistance on Use

Product support and assistance on use are available from STIHL servicing dealers.

For contacts and other information, please visit <https://support.stihl.com> or www.stihl.com.

21 Specifications

21.1 STIHL FSA 135 Brushcutters

- Permitted batteries:
 - STIHL AP
 - STIHL AR
- Weight without battery, cutting tool and deflector: 4.9 kg
- Length without cutting tool: 1840 mm
- Degree of electrical protection: IPX4 (protection against splash water from any direction)

For runtime, see www.stihl.com/battery-life.

21.2 STIHL AP battery

- Battery technology: lithium-ion
- Voltage: 36 V
- Capacity in Ah: see rating label
- Energy content in Wh: see rating label
- Weight in kg: see rating label
- Permissible temperature range for operation and storage: + 10 °C to + 50 °C
- Bluetooth® radio interface (only for batteries with ):
 - Data connection: Bluetooth® 5.1. The mobile appliance must be compatible with

Bluetooth® Low Energy 5.0 and support Generic Access Profile (GAP).

- Frequency band: ISM band 2.4 GHz
- Maximum RF power transmitted: 1 mW
- Signal range: approx. 10 m. The signal strength depends on the ambient conditions and the mobile terminal. Signal range can vary greatly depending on local conditions, including the receiver. The range may be perceptibly reduced inside enclosed rooms and through metal barriers (such as walls, shelves or cases).
- Mobile appliance operating system requirements: Android or iOS (current version or higher)

21.3 Sound Values and Vibration Values

The K-value for sound pressure levels is 2 dB(A).
K-value for sound power levels is 2 dB(A).
The K-value for vibration level is 2 m/s².

STIHL recommends wearing ear defenders.

Using with a mowing head except PolyCut 28-2

- Sound pressure level L_{pA} measured as specified in EN 50636-2-91: 80 dB(A)
- Sound power level L_{wA} measured according to EN 50636-2-91: 92 dB(A)
- Vibration level a_{hv} measured according to EN 50636-2-91
 - Control handle: 2.0 m/s²
 - Left handle: 2.9 m/s²

Using with a mowing head PolyCut 28-2

- Sound pressure level L_{pA} measured according to EN 50636-2-91: 84 dB(A)
- Sound power level L_{WA} measured according to EN 50636-2-91: 97 dB(A)
- Vibration level a_{hv} measured according to EN 50636-2-91
 - Control handle: 2.0 m/s²
 - Left handle: 2.9 m/s²

Using with a metal cutting attachment

- Sound pressure level L_{pA} measured as specified in EN 50636-2-91: 81 dB(A)
- Sound power level L_{WA} measured according to EN 50636-2-91: 94 dB(A)
- Vibration level a_{hv} measured according to EN 50636-2-91
 - Control handle: 1.8 m/s²
 - Left handle: 2.1 m/s²

The vibration levels indicated were measured according to a standardized test method and can

be used as a basis for comparing electric power tools. The vibration levels actually occurring may vary from the values indicated, depending on the type of application. The vibration levels indicated can be used for an initial estimate of the vibration stress. The actual vibration stress has to be estimated. The times when the electric power tool is switched off and the times when it is switched on but running under no load can be taken into account in the estimate.

For information on compliance with Employers' Vibration Directive 2002/44/EC see www.stihl.com/vib.

21.4 REACH

REACH is an EC regulation and stands for the Registration, Evaluation, Authorisation and Restriction of Chemical substances.

For information on compliance with the REACH regulation see www.stihl.com/reach.







22 Combinations of Cutting Attachments, Deflectors and Carrying Systems

22.1 Combinations of Cutting Attachments, Deflectors and Carrying Systems

Cutting attachment	Deflector	Carrying system
<ul style="list-style-type: none"> – PolyCut 28-2 Mowing head with 2.4 mm diameter "round, silent" mowing line: <ul style="list-style-type: none"> – AutoCut 25-2 mowing head – AutoCut C 26-2 mowing head – AutoCut 27-2 mowing head – DuroCut 20-2 mowing head – SuperCut mowing head 20-2 – FixCut 31-2 mowing head Mowing head with 2.7 mm diameter "round, silent" mowing line: <ul style="list-style-type: none"> – AutoCut 36-2 mowing head – Mowing head TrimCut C 32-2 	<ul style="list-style-type: none"> – Guard for mowing heads – Universal deflector with skirt and line limiting blade 	<ul style="list-style-type: none"> – Shoulder strap – Full harness with quick-release system – STIHL AR battery with the support cushion – Battery belt with attached "AP belt bag with connecting cable" together with the shoulder strap – Battery belt with strap and attached "AP belt bag with connecting cable" together with the support cushion – Carrying system with built-in "AP belt bag with connecting cable" together with the support cushion
<ul style="list-style-type: none"> – Grass cutting blade 230-2 (230 mm dia.) – Grass cutting blade 230-4 (230 mm dia.) – Grass cutting blade 230-8 (230 mm dia.) – Grass cutting blade 250-32 (250 mm dia.) – Grass cutting blade 260-2 (260 mm dia.) 	<ul style="list-style-type: none"> – Universal deflector without skirt 	
<ul style="list-style-type: none"> – Brush knife 250-3 (Ø 250 mm) 		
<ul style="list-style-type: none"> – Circular saw blade 200-22 (Ø 200 mm) – Circular saw blade 200-22 HP (Ø 200 mm) 	<ul style="list-style-type: none"> – Limit stop 	<ul style="list-style-type: none"> – Full harness with quick-release system – STIHL AR battery with the support cushion – Battery belt with strap and attached "AP belt bag with connecting cable" together with the support cushion

Cutting attachment	Deflector	Carrying system
		– Carrying system with built-in “AP belt bag with connecting cable” together with the support cushion

Description of the carrying systems

-  Shoulder strap
-  Full harness
-  STIHL AR battery together with the support cushion
-  Battery belt with attached “AP belt bag with connecting cable” together with the shoulder strap
-  Battery belt with strap and attached “AP belt bag with connecting cable” together with the support cushion
-  Carrying system with built-in “AP belt bag with connecting cable” together with the support cushion

23 Spare Parts and Accessories

23.1 Spare parts and accessories

STIHL  These symbols indicate original STIHL spare parts and original STIHL accessories.

STIHL recommends the use of original STIHL spare parts and accessories.

Despite ongoing market observation, STIHL is unable to judge the reliability, safety and suitability of other manufacturers' spare parts and accessories; accordingly, STIHL cannot warrant for the use of those parts.

Original STIHL spare parts and original STIHL accessories are available from STIHL dealers.

24 Disposal

24.1 Disposing of the Trimmer and Battery

Contact the local authorities or your STIHL dealer for information on disposal.

Improper disposal can be harmful to health and pollute the environment.

- ▶ Take STIHL products including packaging to a suitable collection point for recycling in accordance with local regulations.
- ▶ Do not dispose with domestic waste.

25 EC Declaration of Conformity

25.1 STIHL FSA 135 brushcutter

ANDREAS STIHL AG & Co. KG
 Badstraße 115
 D-71336 Waiblingen
 Germany

- declare under our sole responsibility that
- category: Cordless brushcutter
 - Manufacturer's brand: STIHL
 - model: FSA 135
 - serial number: FA01

conforms to the relevant provisions of Directives 2011/65/EU, 2006/42/EC, 2014/30/EU and 2000/14/EC and has been developed and manufactured in compliance with the following standards in the versions valid on the date of produc-

tion: EN 55014-1, EN 55014-2, EN 62233, EN 60335-1 and EN ISO 12100, taking account of standards EN 50636-2-91 and ISO 11806-1.

The measured and guaranteed sound power levels were determined according to Directive 2000/14/EC, Annex VI.

Participating notified body: VDE Prüf- u. Zertifizierungsinstitut, Merianstraße 28, 63069 Offenbach, Germany

- Measured sound power level: 92 dB(A)
- Guaranteed sound power level: 94 dB(A)

The technical documents are stored at ANDREAS STIHL AG & Co. KG Produktzulassung.

The year of manufacture, country of manufacture and serial number are shown on the rating plate of the brushcutter.

Done at Waiblingen, 15.07.2021

ANDREAS STIHL AG & Co. KG

J. Hoffmann
pp

Dr. Jürgen Hoffmann, Director Product Certification & Regulatory Affairs

26 UKCA Declaration of Conformity

26.1 STIHL FSA 135 Brushcutter



ANDREAS STIHL AG & Co. KG
Badstraße 115
D-71336 Waiblingen

Germany

declare under our sole responsibility that

- category: Cordless brushcutter
- Manufacturer's brand: STIHL
- model: FSA 135
- serial number: FA01

complies with the relevant provisions of the UK regulations The Restriction of the Use of Certain Hazardous Substances in Electrical and Electronic Equipment Regulations 2012, Supply of Machinery (Safety) Regulations 2008, Electromagnetic Compatibility Regulations 2016 and

Noise Emission in the Environment by Equipment for use Outdoors Regulations 2001 and has been developed and manufactured in compliance with the following standards in the versions valid on the date of production: EN 55014-1, EN 55014-2, EN 62233, EN 60335-1 and EN ISO 12100 taking into account standards EN 50636-2-91 and ISO 11806-1.

The measured and the guaranteed sound power level have been determined in accordance with UK regulation Noise Emission in the Environment by Equipment for use Outdoors Regulations 2001, Schedule 9.

Participating notified body: INTERTEK Testing & Certification Ltd, Academy Place, 1-9 Brook Street, Brentwood, Essex, CM14 5NQ, United Kingdom

- Measured sound power level: 92 dB(A)
- Guaranteed sound power level: 94 dB(A)

The technical documents are stored at ANDREAS STIHL AG & Co. KG Produktzulassung.

The year of manufacture, country of manufacture and serial number are shown on the rating plate of the brushcutter.

Done at Waiblingen, 15.07.2021

ANDREAS STIHL AG & Co. KG

J. Hoffmann
pp

Dr. Jürgen Hoffmann, Director Product Certification & Regulatory Affairs

www.stihl.com



0458-602-0121-C



0458-602-0121-C