

MS 462 C-M

***STIHL***



2 - 30      Instruction Manual



## Contents

1	Introduction.....	2
2	Guide to Using this Manual.....	2
3	Overview.....	2
4	Safety Precautions.....	4
5	Preparing the Saw for Operation.....	11
6	Assembling the Saw.....	11
7	Engaging and Disengaging the Chain Brake.....	13
8	Mixing Fuel and Refueling the Chainsaw..	13
9	Starting and Stopping the Engine.....	15
10	Checking the Saw.....	16
11	Operating the Saw.....	17
12	After Finishing Work.....	23
13	Transporting.....	23
14	Storing.....	24
15	Cleaning.....	24
16	Maintenance.....	25
17	Repairing.....	26
18	Troubleshooting.....	26
19	Specifications.....	28
20	Bar and Chain Combinations.....	28
21	Spare Parts and Accessories.....	29
22	Disposal.....	29
23	EC Declaration of Conformity.....	29
24	UKCA Declaration of Conformity.....	30

## 1 Introduction

Dear Customer,

Thank you for choosing STIHL. We develop and manufacture our quality products to meet our customers' requirements. The products are designed for reliability even under extreme conditions.

STIHL also stands for premium service quality. Our dealers guarantee competent advice and instruction as well as comprehensive service support.

STIHL expressly commit themselves to a sustainable and responsible handling of natural resources. This user manual is intended to help you use your STIHL product safely and in an environmentally friendly manner over a long service life.

We thank you for your confidence in us and hope you will enjoy working with your STIHL product.

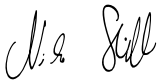

Dr. Nikolas Stihl

**IMPORTANT! READ BEFORE USING AND KEEP IN A SAFE PLACE FOR REFERENCE.**

## 2 Guide to Using this Manual

### 2.1 Symbols used with warnings in the text

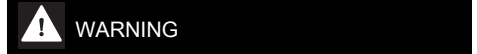

- This symbol indicates dangers that can cause serious injuries or death.
  - ▶ The measures indicated can avoid serious injuries or death.

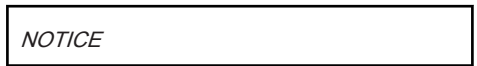

- This symbol indicates dangers that can cause damage to property.
  - ▶ The measures indicated can avoid damage to property.

### 2.2 Symbols in Text



This symbol refers to a chapter in this instruction manual.

## 3 Overview

### 3.1 Chainsaw

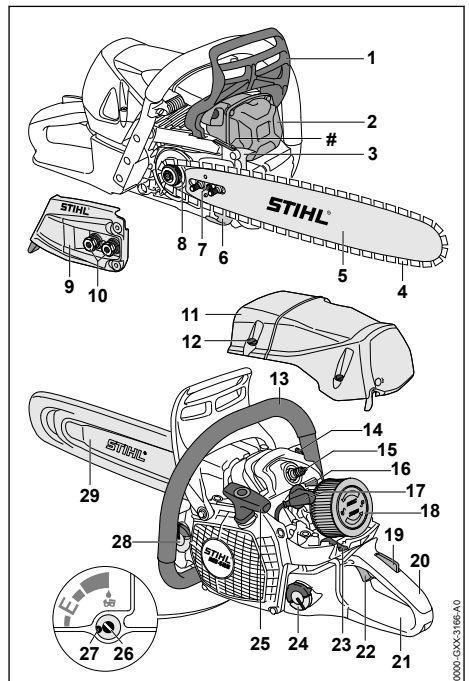

- 1 Front Hand Guard**  
Helps protect operator's left hand from contact with the saw chain, serves to engage the chain brake and activates the chain brake by inertia in certain kickback situations.
- 2 Muffler**  
Reduces chainsaw noise emissions.
- 3 Spiked Bumper**  
Toothed stop for holding saw steady against wood while cutting.
- 4 Saw Chain**  
Cuts the wood.
- 5 Guide Bar**  
Supports and guides the saw chain.
- 6 Chain Catcher**  
Reduces risk of operator contact with the chain if it comes off the bar or breaks.
- 7 Tensioning Screw**  
Adjusts chain tension.
- 8 Chain Sprocket**  
Toothed wheel that drives the chain.
- 9 Chain Sprocket Cover**  
Covers the chain sprocket and secures the guide bar to the chainsaw.
- 10 Nuts**  
Secure chain sprocket cover to the chainsaw.
- 11 Shroud**  
Covers the engine.
- 12 Shroud Fasteners**  
Secure shroud to chainsaw.
- 13 Handlebar (Front Handle)**  
For holding, controlling and carrying the chainsaw.
- 14 Decompression Valve**  
Eases engine starts.
- 15 Spark Plug**  
Ignites fuel-air mixture in the engine.
- 16 Shutter**  
Serves to select summer or winter operating mode.
- 17 Spark Plug Boot**  
Connects ignition lead to spark plug
- 18 Air Filter**  
Filters air entering engine.
- 19 Throttle Trigger Lockout**  
Unlocks the throttle trigger.
- 20 Control Handle**  
For operating, holding and controlling the chainsaw.

- 21 Rear Hand Guard**  
Protects operator's right hand from contact with the chain if it comes off the bar or breaks.
- 22 Throttle Trigger**  
Controls engine speed.
- 23 Master Control Lever**  
For starting, running and stopping the engine.
- 24 Fuel Tank Cap**  
Closes the fuel tank.
- 25 Starter Grip**  
Serves to crank the engine.
- 26 Oil Pump Adjusting Screw**  
Serves to adjust chain oil feed rate.
- 27 Stop**  
Limits travel of oil pump adjusting screw.
- 28 Oil Tank Cap**  
Closes the oil tank.
- 29 Chain Scabbard**  
Helps protect user from contact with saw chain.

## # Serial Number

## 3.2 Features

The chainsaw may be equipped with the following features:

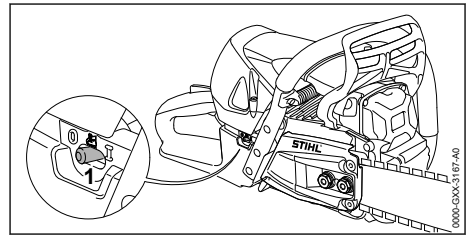

- 1 Handle heating switch**  
Switches the handle heating on and off.  
Heats the front and rear handles.

## 3.3 Symbols

Meanings of symbols that may be on the chainsaw:

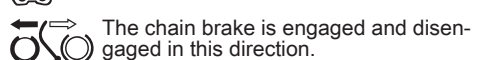
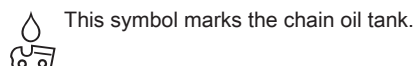
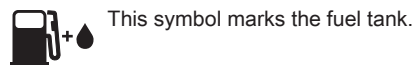



This symbol shows the direction of rotation of the chain.



This symbol marks the oil pump adjusting screw and the chain oil feed rate.



Rotate in this direction to increase chain tension.



Shutter is in winter mode in this position.



Shutter is in summer mode in this position.



This symbol marks the handle heating switch.



This symbol marks the decompression valve.



Master Control lever is moved in this direction to stop the engine.



Master Control lever is moved to this position to stop the engine.



Engine is operated or started with the Master Control lever in this position.



Engine can be started with the Master Control lever in this position.



Guaranteed sound power level according to directive 2000/14/EC in dB(A) in order to make sound emissions of products comparable.

## 4 Safety Precautions

### 4.1 Warning Signs

Meanings of warning signs on the chainsaw:



Observe safety notices and take the necessary precautions.



Read, understand and save the instruction manual.



Wear safety glasses, hearing protection and a hard hat.



Observe safety notices on kickback and take the necessary precautions.

### 4.2 Intended Use

The STIHL MS 462 C-M chainsaw is designed for cutting wood, limbing and felling trees.

## ⚠ WARNING

- Using the chainsaw for purposes for which it is not designed may result in serious or fatal injuries and damage to property.
  - ▶ Use the chainsaw as described in this instruction manual.

### 4.3 The Operator

## ⚠ WARNING

- Users without adequate training or instruction cannot recognize or assess the risks involved in using the chainsaw. The user or other persons may sustain serious or fatal injuries.



- ▶ Read, understand and save the instruction manual.

- ▶ If the chainsaw is passed on to another person: Always give them the instruction manual.
- ▶ Make sure the user meets the following requirements:
  - The user must be rested.
  - The user must be in good physical condition and mental health to operate and work with the chainsaw. If the user's physical, sensory or mental ability is restricted, he or she may work only under the supervision of or as instructed by a responsible person.
  - The user can identify and assess the dangers of the chainsaw.
  - The user must be of legal age or is being trained in a trade under supervision in accordance with national rules and regulations.
  - The user has received instruction from a STIHL servicing dealer or other experienced user before working with the chainsaw for the first time.
  - The user must not be under the influence of alcohol, medication or drugs.
- ▶ If the user is working with a chainsaw for the first time: Practice cutting logs on a sawhorse or other support.
- ▶ If you have any queries: Contact your STIHL servicing dealer for assistance.
- The chainsaw's ignition system produces an electromagnetic field. This field may interfere with some pacemakers. This can result in serious or fatal injuries.
  - ▶ If the user has a pacemaker: Make sure the pacemaker is not affected.

## 4.4 Clothing and Equipment

### ⚠ WARNING

- Long hair can become entangled in the saw during operation. This can result in serious injuries.
  - ▶ Tie up long hair so that it is above shoulder level.
- Objects can be thrown through the air at high speed during operation. This can result in personal injury.



- ▶ Wear close-fitting safety glasses. Suitable safety glasses that have been tested and labeled in accordance with EN 166 or national standards are available from retailers.

- ▶ STIHL recommends that you wear a face shield.
- ▶ Wear a long-sleeved, snug-fitting upper garment.
- Noise occurs during operation. Noise can harm your hearing.



- ▶ Wear hearing protection.

- Falling objects can cause head injuries.



- ▶ If there is a danger of falling objects during operation: Wear a safety hard hat.

- Dust can be whipped up during operation: Whipped up dust can damage the respiratory passages and cause allergic reactions.
  - ▶ If dust is whipped up and forms a cloud: Wear a dust respirator mask.
- Inappropriate clothing can snag on wood, brush or the saw. Not wearing suitable clothing may result in serious injury.
  - ▶ Wear snug-fitting clothing.
  - ▶ Do not wear a scarf or jewelry.
- The user can come into contact with the rotating saw chain during operation. This can result in serious injuries.
  - ▶ Wear long trousers with cut-retardant inserts.
- The user can be cut by the wood during operation. The user can come into contact with the saw chain during cleaning and maintenance work. This can result in personal injury.
  - ▶ Wear work gloves made of durable material.
- Wearing unsuitable footwear may cause you to slip or stumble. Contact with the rotating saw chain can result in cuts. This can result in personal injury.

- ▶ Wear chainsaw boots with cut retardant inserts.

## 4.5 Work Area and Surroundings

### ⚠ WARNING

- Bystanders, children and animals are not aware of the dangers of the chainsaw or thrown objects. Innocent bystanders, children and animals may be seriously injured and damage to property may occur.
  - ▶ Keep bystanders, children and animals away from the work area.
  - ▶ Do not leave the chainsaw unattended.
  - ▶ Make sure that children cannot play with the chainsaw.
- Hot exhaust gas is emitted through the muffler while the engine is running. Hot exhaust gas can ignite easily flammable materials and cause a fire.
  - ▶ Keep exhaust gas well away from easily flammable materials.

## 4.6 Safe Condition

### 4.6.1 Chainsaw

The chainsaw is in a safe condition if the following points are observed:

- The chainsaw is not damaged.
- There is no fuel leaking from the chainsaw.
- The fuel tank and oil tank caps are closed.
- The chainsaw is clean.
- The chain catcher is fitted and undamaged.
- The chain brake is operating properly.
- The controls function properly and have not been modified.
- The chain lubrication is operating properly.
- Wear marks on the chain sprocket are not deeper than 0.5 mm.
- A combination of guide bar and saw chain recommended in this User Manual is mounted.
- The guide bar and saw chain are properly mounted.
- The saw chain is properly tensioned.
- Only original STIHL accessories designed for this chainsaw model are fitted.
- The accessories are correctly attached.

### ⚠ WARNING

- If not in safe condition, components may no longer operate correctly, safety devices may be disabled and fuel leakage may occur. This may result in serious or fatal injury to people.
  - ▶ Work only with an undamaged chainsaw.

- ▶ If fuel is leaking from the chainsaw: Do not use the chainsaw and contact a STIHL dealer for assistance.
- ▶ Close the fuel tank and oil tank caps.
- ▶ If the chainsaw is dirty: Clean the chainsaw.
- ▶ Work only with property fitted and undamaged chain catcher.
- ▶ Never modify your chainsaw. Exception: Mounting a combination of guide bar and saw chain recommended in this User Manual.
- ▶ If the controls do not function properly: Do not use your chainsaw.
- ▶ Only fit original STIHL accessories designed for this chainsaw model.
- ▶ Mount the guide bar and saw chain as described in this User Manual.
- ▶ Attach accessories as described in this User Manual or in the User Manual for the accessories.
- ▶ Never insert objects in the chainsaw's openings.
- ▶ Replace worn or damaged labels.
- ▶ If you have any doubts, be sure to consult a STIHL dealer.

#### 4.6.2 Guide Bar

The guide bar is in a safe condition if the following points are observed:

- Guide bar is not damaged.
- Guide bar is not deformed.
- The minimum groove depth is maintained,  19.3.
- Bar rails are free from burrs.
- Bar groove is not pinched or splayed.

### WARNING

- If the guide bar is not in a safe condition, it can no longer support and guide the saw chain properly. The rotating saw chain can jump off the guide bar. This can result in serious or fatal injuries.
  - ▶ Work only with an undamaged guide bar.
  - ▶ If the groove depth is less than the minimum depth: Mount a new guide bar.
  - ▶ Deburr the guide bar every week.
  - ▶ If you have any queries: Contact your STIHL servicing dealer.

#### 4.6.3 Saw Chain

The saw chain is in a safe condition if the following points are observed:

- Chain is not damaged.
- Chain is properly sharpened.
- The service marks on the cutters are still visible.

### WARNING

- If components do not comply with safety requirements, they will no longer function properly and safety devices may be rendered inoperative. This can result in serious or fatal injuries.
  - ▶ Work only with an undamaged saw chain.
  - ▶ Sharpen the chain properly.
  - ▶ If you have any queries: Contact your STIHL servicing dealer for assistance.

## 4.7 Fuel Mixture and Refueling

### WARNING

- This chainsaw requires a fuel mixture of gasoline and two-stroke engine oil. Mixed fuel and gasoline are extremely flammable. If fuel mixture or gasoline make contact with open fire or hot objects, they can cause a fire or explosions. Persons may be seriously or fatally injured and property may be damaged.
  - ▶ Protect fuel mixture and gasoline from heat and fire.
  - ▶ Do not spill mixed fuel or gasoline.
  - ▶ If fuel has been spilled: Wipe up fuel with a cloth and do not attempt to start engine until all parts of the chainsaw are dry.
  - ▶ Do not smoke.
  - ▶ Never refuel near a fire.
  - ▶ Shut off the engine and allow it to cool down before refueling.
  - ▶ Start the engine at least 3 meters from the fueling spot, outdoors only.
- Inhaling fuel fumes and gasoline fumes can have toxic effects.
  - ▶ Avoid inhaling fuel fumes or gasoline fumes.
  - ▶ Refuel in a well-ventilated location.
- The chainsaw will become hot during operation, or in a very hot environment. Depending on the type of fuel, altitude, ambient temperature and the temperature of the saw, the fuel expands and can cause a build-up of pressure in the tank. Fuel may spray out and ignite when the fuel tank cap is opened. The user may be seriously injured and property damage may occur.
  - ▶ Allow the chainsaw to cool down before opening the fuel tank cap.
  - ▶ Open the fuel tank cap slowly and not all at once.
- Clothing that has been in contact with fuel or gasoline will become more easy to ignite. Persons may be seriously or fatally injured and property may be damaged.

- ▶ If your clothing comes into contact with fuel or gasoline: Change your clothing.
- Fuel mix, gasoline and two-stroke engine oil can harm the environment.
  - ▶ Do not spill fuel, gasoline or two-stroke engine oil.
  - ▶ Dispose of fuel mix, gasoline and two-stroke engine oil in accordance with local regulations and environmental requirements.
- Fuel, gasoline or two-stroke engine oil can cause irritation if they come into direct contact with the skin or eyes.
  - ▶ Avoid contact with fuel, gasoline and two-stroke engine oil.
  - ▶ If skin contact occurs: Wash affected areas of skin with plenty of water and soap.
  - ▶ If eye contact occurs: Flush eyes with plenty of water for at least 15 minutes and consult a doctor.
- The ignition system of the chainsaw generates sparks. Unconfined sparks may cause a fire or an explosion in an easily combustible or explosive environment. Persons may be seriously or fatally injured and property may be damaged.
  - ▶ Use the spark plugs described in this instruction manual.
  - ▶ Insert and tighten down the spark plug.
  - ▶ Connect the spark plug boot and press it down firmly.
- The saw can be damaged if it is run on a mixture of fuel which includes unsuitable gasoline or unsuitable two-stroke engine oil, or if an incorrect mix ratio of gasoline and two-stroke engine oil is used.
  - ▶ Mix the fuel as described in this instruction manual.
- The mixture of gasoline and two-stroke engine oil can separate or age if it is stored for a long period. The chainsaw can be damaged if it is used with a fuel mix that has separated or has aged.
  - ▶ Before refueling the saw: Thoroughly mix the fuel.
  - ▶ Use a mixture of gasoline and two-stroke engine oil that is not older than 30 days (STIHL MotoMix: 5 years).
- ▶ Make sure than persons outside the work area are within calling distance.
- If the engine is not started properly, the user may lose control of the chainsaw. This can result in serious injuries.
  - ▶ Start the engine as described in this instruction manual.
  - ▶ If the saw chain is touching the ground or objects: Do not start the engine.
- The user cannot concentrate on the work in certain situations. The user can lose control of the saw, trip or fall and be seriously injured.
  - ▶ Work calmly and carefully.
  - ▶ If light and visibility are poor: Do not use your saw.
  - ▶ Operate the chainsaw alone.
  - ▶ Do not work above shoulder height.
  - ▶ Watch out for obstacles.
  - ▶ Stand on the ground while working and keep a good balance. If it is necessary to work at heights: Use a lift bucket or a safe platform.
  - ▶ If you begin to feel tired: Take a break.
- Exhaust gas is produced when the engine is running. Breathing in exhaust gas can have toxic effects.
  - ▶ Avoid inhaling exhaust gas.
  - ▶ Operate the chainsaw in a well ventilated location.
  - ▶ In the event of nausea, headache, visual disturbances, problems with hearing or dizziness: Stop work and seek medical advice.
- The user's ability to hear and assess noises is restricted when wearing hearing protection with the engine running.
  - ▶ Work calmly and carefully.
- The user will not be able to control the chainsaw properly if it is operated with the Master Control lever in position ▲. This can result in serious injuries.
  - ▶ Move the Master Control lever to position I.
  - ▶ Start the engine as described in this instruction manual.
- Do not accelerate the engine with the chain brake engaged since this can damage the chain brake.
  - ▶ Disengage the chain brake before you start cutting.
- The rotating saw chain can cut the operator. This can result in serious injuries.
  - ▶ Do not touch the rotating saw chain.
  - ▶ If the saw chain is blocked by an object: Shut off the engine and engage the chain brake. Then remove the object causing the blockage.

## 4.8 Working

### 4.8.1 Sawing

#### **▲ WARNING**

- Always work within calling distance of others in case help is needed.

- The rotating chain becomes hot and expands. If the chain is not lubricated sufficiently and retensioned, it can come off the guide bar or break. This can result in serious injuries and damage to property.
  - ▶ Use special chain oil.
  - ▶ Check chain tension regularly during cutting work. If chain tension is insufficient: Tension the chain.
- If the behavior of the saw changes during operation or feels unusual, it may no longer be in a safe condition. This can result in serious injuries and damage to property.
  - ▶ Stop work and contact your STIHL dealer for assistance.
- Saw vibrations may occur during operation.
  - ▶ Wear gloves.
  - ▶ Take regular breaks.
  - ▶ If signs of circulation problems occur: Seek medical advice.
- Sparks may occur if the rotating chain makes contact with a hard object. Sparks may cause a fire in an easily combustible location. This can result in serious or fatal injuries and damage to property.
  - ▶ Do not work in an easily combustible location.
- Note that the saw chain continues to rotate for a short period after you release the trigger. The rotating saw chain can cut the user. This can result in serious injuries.
  - ▶ Wait for the chain to come to a standstill.

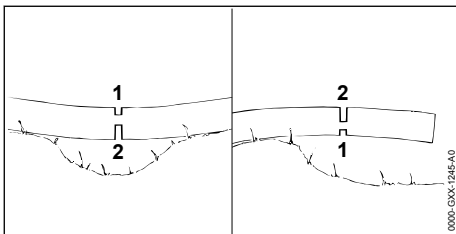

## ▲ WARNING

- The guide bar can be pinched when cutting wood that is under tension. The user can lose control of the saw and be seriously injured.
  - ▶ Make a relieving cut in the compression side (1) first, then perform bucking cut at the tension side (2).

### 4.8.2 Limbing

## ▲ WARNING

- If the underside of the felled tree is limbed first, it will no longer be supported on the

ground by branches. The tree can move during cutting work. This can result in serious or fatal injuries.

- ▶ Cut through large limbs on the underside of the tree only after it has been bucked.
- ▶ Do not stand on the log while limbing it.
- A branch may fall to the ground during limbing. The user may trip, fall or be seriously injured.
  - ▶ Limb from the base to the crown of the tree.

### 4.8.3 Felling

## ▲ WARNING

- Inexperienced users cannot assess the dangers when felling a tree. Persons may be seriously or fatally injured and property may be damaged.
  - ▶ The user needs relevant knowledge of felling technology and experience of felling work.
  - ▶ If anything is unclear, consult an experienced expert for assistance and to determine the appropriate felling technique.
- A tree and branches can fall on bystanders or objects during felling. The larger the falling parts are, the greater the risk of serious or fatal injury to people. Damage to property may occur.
  - ▶ Determine direction of fall so that the area in which the tree falls is clear.
  - ▶ Do not allow bystanders, children or animals within 2.5 tree lengths of the work area.
  - ▶ Remove broken or dead branches from the tree crown before felling.
  - ▶ If bent or withered branches cannot be removed from the tree crown, consult an experienced expert for assistance and to determine the appropriate felling technique.
  - ▶ Be aware of the tree crown and crowns of neighboring trees, and keep clear of falling branches.
- When the tree falls the trunk could break or spring back in the direction of the user. This may result in serious or fatal injury to the user.
  - ▶ Plan a sideways escape path behind the tree.
  - ▶ Walk backwards along the escape path and observe the falling tree.
  - ▶ Do not walk backwards down slopes.
- Obstacles in the work area and on the escape path can hinder the user. The user may trip and fall. This may result in serious or fatal injury to the user.
  - ▶ Remove all obstacles from the work area and escape path.



- If you cut into or through the hinge, stabilizing strap or holding strap too soon, the intended direction of fall cannot be controlled or the tree may fall prematurely. Persons may be seriously or fatally injured and property may be damaged.
  - ▶ Do not cut into or through the hinge.
  - ▶ Cut through the stabilizing strap or holding strap last.
  - ▶ If the tree begins to fall too soon: Abandon the felling cut and retreat along the escape path.
- Kickback can occur if the rotating chain in the upper quadrant of the bar nose makes contact with a hard felling wedge and is suddenly braked. There is a risk of serious or fatal injury.
  - ▶ Use aluminum or plastic felling wedges.
- If the tree does not fall all the way to the ground or gets caught on another tree, the operator cannot finish the operation in a controlled manner.
  - ▶ Stop the felling operation and use a cable winch or suitable vehicle to pull the tree to the ground.

## 4.9 Reactive Forces

### 4.9.1 Kickback

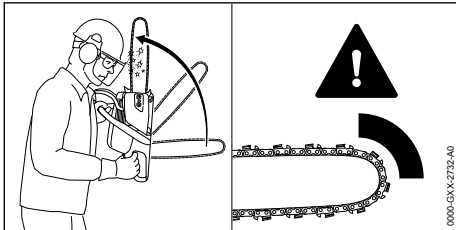

Kickback can be caused for the following reasons:

- The rotating saw chain in the upper quadrant of the bar nose makes contact with a hard object and is suddenly braked.
- The rotating saw chain is pinched at the bar nose.

The chain brake cannot prevent kickback.

## ▲ WARNING

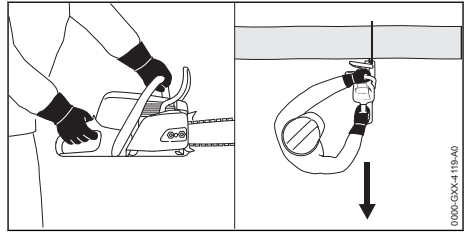

- If kickback occurs, the saw can be thrown up in the direction of the operator. The operator can lose control of the saw and be seriously or fatally injured.
  - ▶ Hold the saw firmly with both hands.
  - ▶ Always keep your body out of the plane of the cutting attachment.
  - ▶ Use the working techniques described in this instruction manual.
  - ▶ Do not cut with the upper quadrant of the bar nose.
  - ▶ Always cut with a properly sharpened and tensioned saw chain.
  - ▶ Use a reduced kickback saw chain.
  - ▶ Use a guide bar with a narrow radius nose.
  - ▶ Always cut with the chain running at full speed.

### 4.9.2 Pull-in

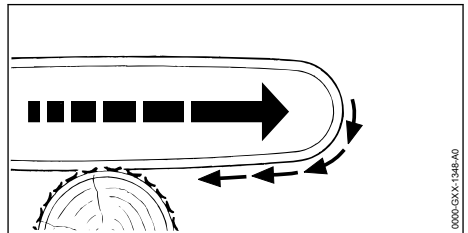

The saw is pulled away from the operator when the bottom of the bar is used for cutting.

## ▲ WARNING

- If the rotating chain makes contact with a hard object and is suddenly pinched, the saw is abruptly jerked away from the operator. The operator can lose control of the saw and be seriously or fatally injured.
  - ▶ Hold the saw firmly with both hands.
  - ▶ Operate the saw as described in this instruction manual.
  - ▶ Keep the guide bar straight in the cut.
  - ▶ Apply the spiked bumper properly.
  - ▶ Always cut with the chain running at full speed.

### 4.9.3 Pushback

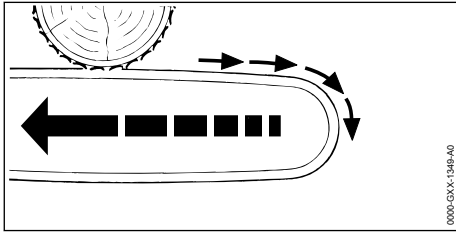

The saw is pushed back toward the operator when the top of the bar is used for cutting.

### ▲ WARNING

- If the rotating chain makes contact with a hard object and is suddenly pinched, the saw can be abruptly pushed back toward the operator. The operator can lose control of the saw and be seriously or fatally injured.
  - ▶ Hold the saw firmly with both hands.
  - ▶ Operate the saw as described in this instruction manual.
  - ▶ Keep the guide bar straight in the cut.
  - ▶ Always cut with the chain running at full speed.

### 4.10 Transport

### ▲ WARNING

- The saw may turn over or shift during transport. This may result in serious injury to people and damage to property.
  - ▶ Shut off the engine.
  - ▶ Engage the chain brake.
  - ▶ Fit the chain scabbard so that it completely covers the guide bar.
  - ▶ Secure the chainsaw with lashing straps, belts or a net to prevent it turning over and moving.

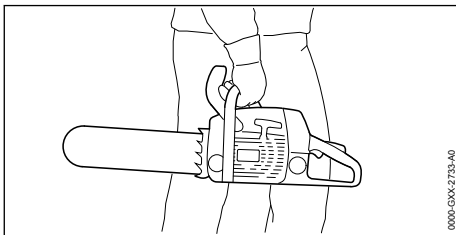

- The muffler and engine may be hot after a period of operation. There is a risk of burn injuries.
  - ▶ Carry the chainsaw by holding the front handle in your right hand with the guide bar pointing to the rear.

### 4.11 Storing

### ▲ WARNING

- Children are not aware of and cannot assess the dangers of a chainsaw and can be seriously injured.
  - ▶ Shut off the engine.
  - ▶ Engage the chain brake.
  - ▶ Fit the scabbard so that it completely covers the guide bar.
  - ▶ Store the saw out of the reach of children.
- Dampness can corrode the electrical contacts on the saw and metal components. This can damage the saw.
  - ▶ Store the saw in a clean and dry condition.

### 4.12 Cleaning, Maintenance and Repair

### ▲ WARNING

- The saw chain can start up unintentionally if the engine is running during cleaning, maintenance or repair operations. This may result in serious injury to people and damage to property.
  - ▶ Shut off the engine.
  - ▶ Engage the chain brake.
- The muffler and engine may be hot after a period of operation. This can result in burn injuries.
  - ▶ Wait until the muffler and engine cool down.
- Aggressive cleaning agents, a water jet or pointed objects can damage the chainsaw, guide bar and saw chain. If the chainsaw, guide bar or saw chain are not cleaned correctly, components may no longer function properly or safety devices may be rendered inoperative. They may cause serious injury to persons.
  - ▶ Clean the chainsaw, guide bar and saw chain as described in this user manual.
- If the chainsaw is not maintained as described in this user manual, components may no longer function properly or safety devices may be rendered inoperative. This may result in serious or fatal injury to people.
  - ▶ Service or repair the chainsaw as described in this user manual.
- If the guide bar and saw chain are not maintained or repaired as described in this user manual, components may no longer function properly or safety devices may be rendered inoperative. They may cause serious injury to persons.

- ▶ Service or repair the guide bar and saw chain as described in this User Manual.
- The user may be cut by the sharp cutters while cleaning or servicing the saw chain. This may result in injury to the user.
  - ▶ Wear work gloves made from resistant material.

## 5 Preparing the Saw for Operation

### 5.1 Preparing the Saw for Operation

Perform the following steps before starting work:

- ▶ Make sure the following components are in a safe condition:
  - Chainsaw, 4.6.1.
  - Guide bar, 4.6.2.
  - Saw chain, 4.6.3.
- ▶ Clean the saw, 15.1.
- ▶ Mount the bar and chain, 6.1.1.
- ▶ Tension the saw chain, 6.2.
- ▶ Fill up with chain oil, 6.3.
- ▶ Check the chain brake, 10.4.
- ▶ Refuel the saw, 8.2.
- ▶ Check the controls, 10.5.
- ▶ Check chain lubrication, 10.6.
- ▶ If you cannot carry out these steps: Do not use your chainsaw and contact your STIHL servicing dealer for assistance.

## 6 Assembling the Saw

### 6.1 Mounting and Removing the Bar and Chain

#### 6.1.1 Mounting the Bar and Chain

The bar and chain combinations that can be used with the chain sprocket are listed in the specifications, 20.1.

- ▶ Shut off the engine and engage the chain brake.

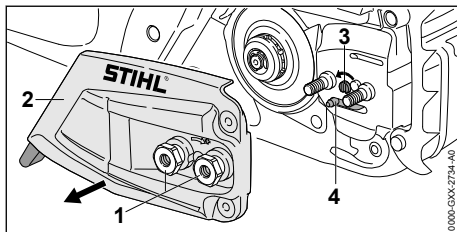

- ▶ Rotate the nuts (1) counterclockwise until the chain sprocket cover (2) can be removed.
- ▶ Remove the chain sprocket cover (2).

- ▶ Turn the tensioning screw (3) counterclockwise until the tensioner slide (4) butts against the left end of the housing.

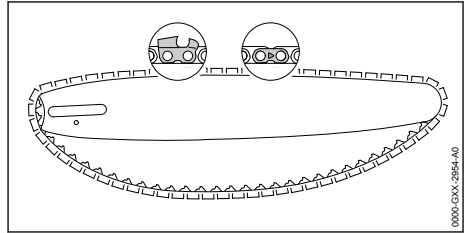

- ▶ Fit the chain in the bar groove so that the arrows on the tie straps on the top of the bar point in the direction of rotation.

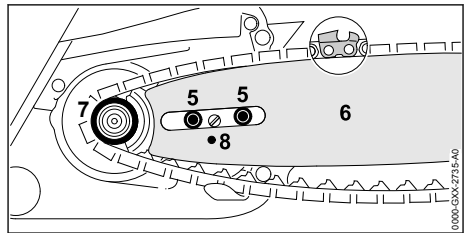

- ▶ Fit the guide bar and chain on the saw and check the following points:
  - Chain drive links are seated in teeth of chain sprocket (7).
  - Collar studs (5) are located in slot in tail of guide bar (6).
  - Peg of tensioner slide (4) engages hole (8) in guide bar (6).

The guide bar (6) may be either way round. The logo on the guide bar (6) may also be upside down.

- ▶ Disengage the chain brake.

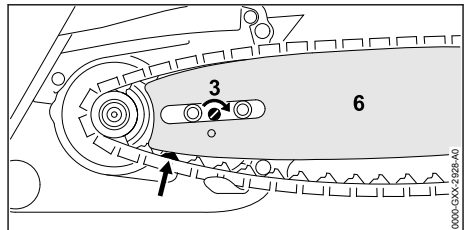

- ▶ Turn the tensioning screw (3) clockwise until the chain fits snugly against the bar. Make sure the drive link tangs engage the bar groove. The guide bar (6) and chain are seated against the saw.

- ▶ Fit the sprocket cover (2) so that it is flush with the saw.
- ▶ Fit and tighten down the nuts (1) firmly.

### 6.1.2 Removing the Bar and Chain

- ▶ Shut off the engine and engage the chain brake.
- ▶ Rotate the nuts counterclockwise until the chain sprocket cover can be removed.
- ▶ Remove the sprocket cover.
- ▶ Turn the tensioning screw counterclockwise as far as stop.  
The chain is now slack.
- ▶ Remove the bar and chain.

## 6.2 Tensioning the Saw Chain

The saw chain expands or contracts during cutting work. Chain tension changes as a result. Check chain tension regularly during operation and readjust if necessary.

- ▶ Shut off the engine and engage the chain brake.

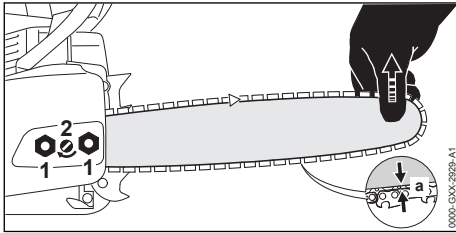

- ▶ Loosen the nuts (1).
- ▶ Disengage the chain brake.
- ▶ Hold the bar nose up and turn the tensioning screw (2) clockwise until the following points apply:
  - Chain sag 'a' in the center of the bar is 1 - 2 mm.
  - The chain can still be pulled easily along the bar with two fingers.
- ▶ Keep holding the bar nose up and tighten down the nuts (1) firmly.
- ▶ If chain sag 'a' in the center of the bar is not 1 - 2 mm: Readjust chain tension.

## 6.3 Filling Up with Chain Oil

Chain oil lubricates and cools the rotating chain.

- ▶ Shut off the engine and engage the chain brake.
- ▶ Place your saw on a level surface so that the oil tank cap faces up.
- ▶ Use a damp cloth to clean the tank cap and the area around it.

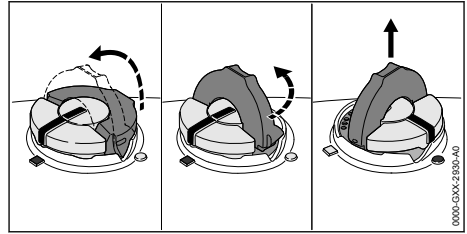

- ▶ Swing the grip on the oil tank cap to the vertical position.
- ▶ Turn the oil tank cap counterclockwise as far as stop.
- ▶ Remove the oil tank cap.
- ▶ Fill up with chain oil, taking care not to spill any oil and do not overfill the tank.
- ▶ If the grip on the oil tank cap has dropped into the closed position: Raise the grip until it is vertical.

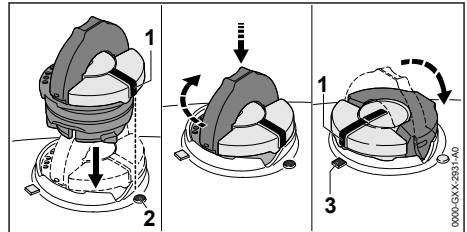

- ▶ Place the cap in the filler opening so that mark (1) lines up with mark (2).
- ▶ Press the cap down and rotate it clockwise as far as stop.  
The cap snaps into place. The mark (1) points to mark (3).
- ▶ Check to see if the oil tank cap can be pulled upwards and off.
- ▶ If the oil tank cap cannot be pulled upwards and off: Fold down the grip on the oil tank cap. The oil tank is closed.

If the oil tank cap can be pulled upwards and off, perform the following steps:

- ▶ Place the oil tank cap in the filler opening – in any position.

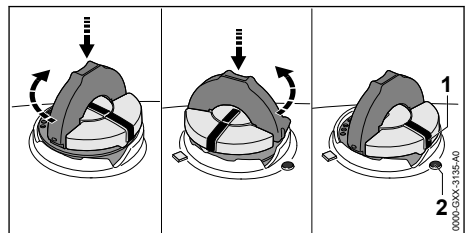

- ▶ Press the cap down and rotate it clockwise as far as stop.
- ▶ Press the cap down and rotate it counterclockwise until mark (1) points to mark (2).
- ▶ Now try again to close the oil tank.
- ▶ If the oil tank still cannot be closed properly: Do not use the chainsaw and contact a STIHL dealer for assistance. The chainsaw is not in a safe condition.

## 6.4 Mounting the Spiked Bumper

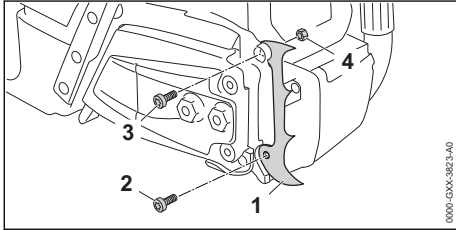

- ▶ Place the spiked bumper (1) in position.
- ▶ Fit the screw (2).
- ▶ Insert screw (3) through spiked bumper and nut (4).
- ▶ Tighten down the screws (2) and (3) firmly.

The spiked bumper (1) must not be removed.

## 7 Engaging and Disengaging the Chain Brake

### 7.1 Engaging the Chain Brake

The saw is equipped with a chain brake.

The chain brake is activated by the inertia of the front hand guard if the kickback force is high enough or can be engaged by the operator.

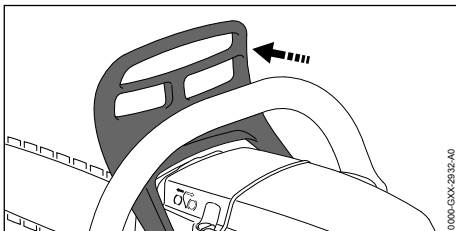

- ▶ Push the hand guard away from the front handle with your left hand. The hand guard engages with an audible click. The chain brake is engaged.

### 7.2 Disengaging the Chain Brake

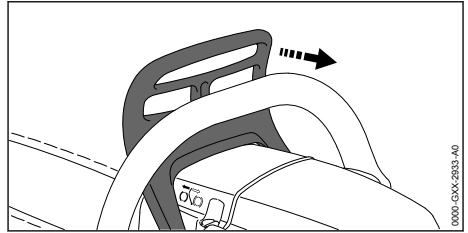

- ▶ Pull the hand guard toward the front handle with your left hand. The hand guard engages with an audible click. The chain brake is disengaged.

## 8 Mixing Fuel and Refueling the Chainsaw

### 8.1 Mixing fuel

The fuel required for this chainsaw is a mixture of two-stroke engine oil and gasoline, in a mixing ratio of 1:50.

STIHL recommends you use STIHL MotoMix.

If you mix the fuel yourself, use only STIHL two-stroke engine oil or another high-performance engine oil in accordance with JASO FB, JASO FC, JASO FD, ISO-L-EGB, ISO-L-EGC or ISO-L-EGD.

STIHL specifies STIHL HP Ultra two-stroke engine oil or an equivalent high-performance engine oil in order to maintain emission limits over the machine's service life.

- ▶ Make sure that the octane number of the gasoline is at least 90 RON and the ethanol content is not more than 10% (for Brazil: 27%).
- ▶ Make sure the two-stroke engine oil you are using meets the requirements.
- ▶ Depending on the desired amount of fuel, determine the correct amounts of two-stroke engine oil and gasoline in a mixing ratio of 1:50. Examples for fuel mixes:
  - 20 ml Two-stroke engine oil, 1 l gasoline
  - 60 ml Two-stroke engine oil, 3 l gasoline
  - 100 ml Two-stroke engine oil, 5 l gasoline
- ▶ Pour two-stroke engine oil into a clean approved fuel canister first and then add gasoline.
- ▶ Thoroughly mix the fuel before topping up.

## 8.2 Filling up the Chainsaw with Fuel

- ▶ Shut off the engine and engage the chain brake.
- ▶ Allow the chainsaw to cool down.
- ▶ Place your chainsaw on a level surface so that the fuel tank cap faces up.
- ▶ Use a damp cloth to clean the fuel tank cap and the area around it.
- ▶ Fold out the handle on the fuel tank cap.

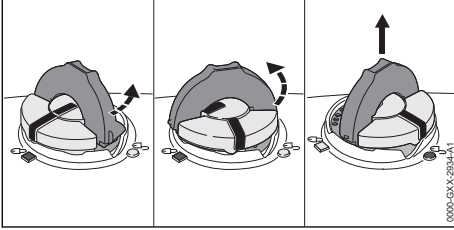

### WARNING

- The chainsaw will become hot during operation, or in a very hot environment. Depending on the type of fuel, altitude, ambient temperature and the temperature of the saw, the fuel expands and can cause a build-up of pressure in the tank. Fuel may spray out and ignite when the fuel tank cap is opened. The user may be seriously injured and property damage may occur.
  - ▶ Allow the chainsaw to cool down before opening the fuel tank cap.
  - ▶ Open the fuel tank cap slowly and not all at once.

- ▶ Turn the fuel tank cap about 1/8-of-a-turn counterclockwise. If the fuel tank is under pressure, you will hear the overpressure being released.
- ▶ When the tank is no longer under pressure: Turn the fuel tank cap counterclockwise until the marks on the cap and fuel tank are in alignment.
- ▶ Remove the fuel tank cap.

### NOTICE

- Exposure to light, direct sunlight and extreme temperatures may accelerate fuel separation or aging. Topping the chainsaw up with unmixed or older fuel may damage the chainsaw.
  - ▶ Thoroughly mix the fuel before topping up.
  - ▶ Do not top up with fuel stored for more than 30 days (STIHL MotoMix: 5 years).

- ▶ When topping up, ensure that no fuel is spilled and that the fuel level remains at least 15 mm under the edge of the tank.
- ▶ If the handle on the fuel tank cap has dropped into the closed position: Fold out the handle.

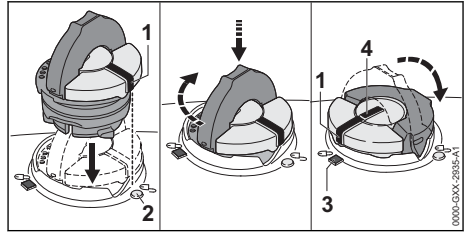

- ▶ Place the fuel tank cap in the filler opening so that mark (1) lines up with mark (2).
- ▶ Press the fuel tank cap down and rotate it clockwise until it stops. The fuel tank cap snaps into place. Mark (1) is in line with mark (4) and points to mark (3).
- ▶ Check to see if the fuel tank cap can be pulled up and off.
- ▶ If the fuel tank cap cannot be pulled up and off: Fold the handle flat to the top of the cap. The fuel tank is closed.

If the fuel tank cap can be pulled up and off, perform the following steps:

- ▶ Place the fuel tank cap in the filler opening – in any position.

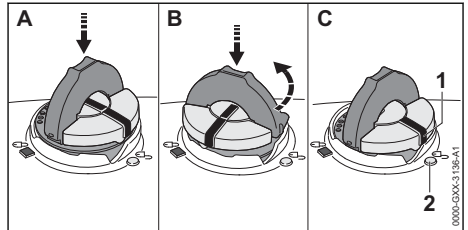

- ▶ Press the fuel tank cap down and rotate it clockwise until it stops.
- ▶ Press the cap down and rotate it counterclockwise until mark (1) points to mark (2).
- ▶ Now try again to close the fuel tank.
- ▶ If the fuel tank still cannot be closed properly: Do not use the chainsaw and contact a STIHL dealer for assistance. The chainsaw is not in a safe condition.

## 9 Starting and Stopping the Engine

### 9.1 Starting the Engine

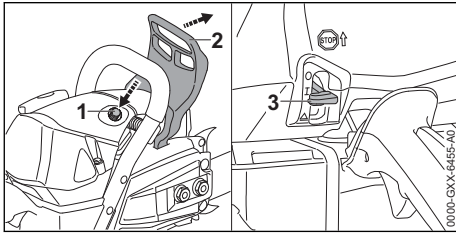

- ▶ Engage the chain brake (2).
- ▶ Pull off the chain guard (scabbard).
- ▶ Depress the decompression valve (1).
- ▶ Move the Master Control lever (3) to position **I**.
- ▶ If the engine is at ambient temperature:

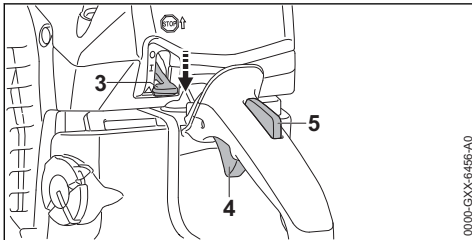

- ▶ Press down the throttle trigger lockout (5) and hold it there.
- ▶ Pull the throttle trigger (4) and hold it there.
- ▶ Move the Master Control lever (3) to position **▲** and hold it there.
- ▶ Release the throttle trigger (4) and lockout lever (5). The Master Control lever (3) engages in position **▲**.

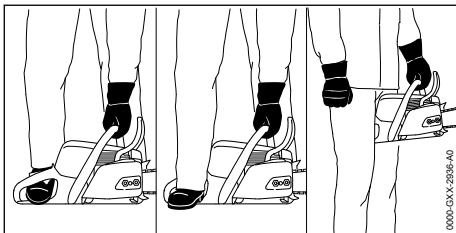

- ▶ Hold the chainsaw firmly in one of three ways:
  - Place the saw on level ground. Hold the saw firmly on the ground with your left hand on the handlebar – your thumb should be under the handle. Put the toe of your right boot into the rear handle and press down.

- Place the saw on level ground. Hold the saw firmly on the ground with your left hand on the handlebar – your thumb should be under the handle. Put the heel of your right boot into the rear handle and press down.
- Hold the saw firmly with your left hand on the handlebar – your thumb should be under the handle. Hold the rear handle tightly between your legs, just above the knees.



- ▶ Pull the starter grip slowly with your right hand until you feel it engage.
- ▶ Pull the starter grip quickly and allow the starter rope to rewind several times until the engine runs.
- ▶ If the Master Control lever (3) is in position **▲**. Briefly depress the lockout lever (4) and blip the throttle trigger (5). The Master Control lever springs to position **I**. The engine runs at idling speed.

#### NOTICE

- Do not accelerate the engine with the chain brake engaged since this can damage the chain brake.
  - ▶ Disengage the chain brake before you start cutting.
- ▶ Disengage the chain brake. Your saw is ready for operation.
- ▶ If the saw chain rotates while the engine is idling:
  - ▶ Shut off the engine and engage the chain brake.
  - ▶ Do not use your chainsaw and contact your STIHL servicing dealer for assistance. The saw has a malfunction.
- ▶ If the engine does not start: Move the Master Control lever (3) to position **▲** and try again to start the engine.

## 9.2 Shut off the engine.

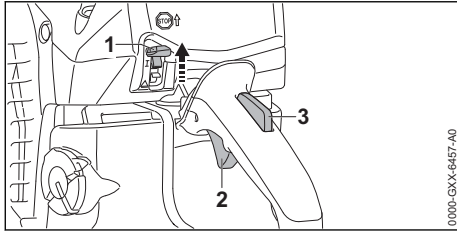

- ▶ Release the throttle trigger (2) and lockout lever (3).  
The saw chain stops running.
- ▶ Move the Master Control lever (1) to position **I**.  
The engine stops and the Master Control lever (1) springs back to position **I**.
- ▶ If the engine does not stop:
  - ▶ Move the Master Control lever to position **▲**.  
The engine stops.
  - ▶ Do not use your chainsaw and contact your STIHL servicing dealer for assistance.  
The saw has a malfunction.

## 10 Checking the Saw

### 10.1 Checking the Chain Sprocket

- ▶ Shut off the engine.
- ▶ Disengage the chain brake.
- ▶ Remove the chain sprocket cover.
- ▶ Remove the bar and chain.

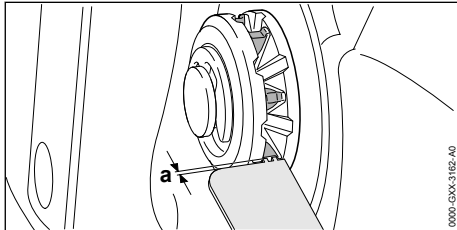

- ▶ Use a STIHL gauge to check the wear marks on the sprocket.
- ▶ If wear marks are deeper than  $a = 0.5 \text{ mm}$ : Do not use your chainsaw and contact your STIHL servicing dealer for assistance.  
The chain sprocket must be replaced.

### 10.2 Checking the Guide Bar

- ▶ Shut off the engine and engage the chain brake.
- ▶ Remove the chain and guide bar.

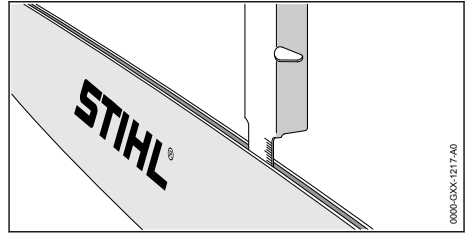

- ▶ Measure depth of bar groove with scale on STIHL filing gauge.
- ▶ Install a new guide bar if one of the following points applies:
  - Guide bar is damaged.
  - Measured bar groove depth is less than specified minimum depth, **19.3**.
  - Bar groove is pinched or splayed.
- ▶ If you have any queries: Contact your STIHL servicing dealer for assistance.

### 10.3 Checking the Saw Chain

- ▶ Shut off the engine and engage the chain brake.

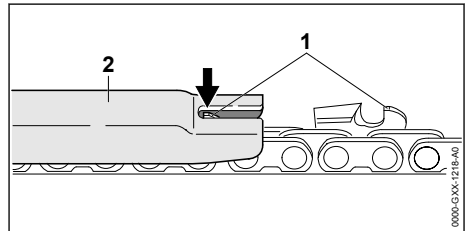

- ▶ Use a STIHL filing gauge (2) to check the height of the depth gauges (1). The STIHL filing gauge must match the chain pitch.
- ▶ If a depth gauge (1) projects from the filing gauge (2): Lower the depth gauge (1), **16.3**.

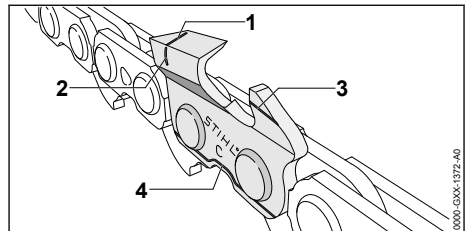

- ▶ Make sure the service marks (1 to 4) on the cutters are visible.
- ▶ If one of the service marks is not visible on a cutter: Do not use your chainsaw and contact your STIHL servicing dealer for assistance.



- ▶ Use a STIHL filing gauge to check that a filing angle of 30° has been maintained on all cutters. The STIHL filing gauge must match the chain pitch.
- ▶ If a filing angle of 30° has not been maintained: Resharpen the saw chain.
- ▶ If you have any queries: Contact your STIHL servicing dealer for assistance.

## 10.4 Testing the Chain Brake

- ▶ Shut off the engine and engage the chain brake.

### **!** WARNING

- The chain's cutters are very sharp. There is a risk of cut injuries.
    - ▶ Wear work gloves made of durable material.
- 
- ▶ Try to pull the chain along the guide bar by hand. If the chain cannot be pulled along the bar by hand, the chain brake is functioning.
  - ▶ If the chain can be pulled along the bar by hand: Do not use your chainsaw and contact your STIHL servicing dealer for assistance. The chain brake is defective.

## 10.5 Checking the Controls

### Throttle trigger lockout and throttle trigger

- ▶ Shut off the engine and engage the chain brake.
- ▶ Attempt to pull the trigger without depressing the lockout lever.
- ▶ If the trigger can be pulled: Do not use your chainsaw and contact your STIHL servicing dealer for assistance. There is a malfunction in the throttle trigger lockout.
- ▶ Press down the throttle trigger lockout and hold it there.
- ▶ Pull the throttle trigger and release it again.
- ▶ If the throttle trigger is stiff or does not spring back to its idle position: Do not use your chainsaw and contact your STIHL servicing dealer for assistance. The throttle trigger is defective.

### Stopping the Engine

- ▶ Start the engine.
- ▶ Move the Master Control lever to position **C**. The engine stops and the Master Control lever springs back to position **I**.
- ▶ If the engine does not stop:

- ▶ Move the Master Control lever to position **A**. The engine stops.
- ▶ Do not use your chainsaw and contact your STIHL servicing dealer for assistance. Your saw has a malfunction.

## 10.6 Checking Chain Lubrication

- ▶ Start the engine and disengage the chain brake.
- ▶ Hold the guide bar over a light surface.
- ▶ Open the throttle. Chain oil is thrown off the chain and is visible on the light surface. Chain lubrication is operating properly.
- ▶ If no chain oil can be seen:
  - ▶ Shut off the engine.
  - ▶ Fill up with chain oil.
  - ▶ Check chain lubrication again.
  - ▶ If chain oil is still not visible on the light surface: Do not use your chainsaw and contact your STIHL servicing dealer for assistance. Chain lubrication is defective.

## 11 Operating the Saw

### 11.1 Winter Operation

The carburetor may ice up when the saw is used at temperatures below +10°C. The shutter must be set to the winter mode so that carburetor is additionally heated by warm air from around the engine.

#### NOTICE

- The engine may overheat if the saw is left in the winter mode at temperatures above +10°C.
  - ▶ Change setting to summer mode.
- ▶ Shut off the engine and engage the chain brake.

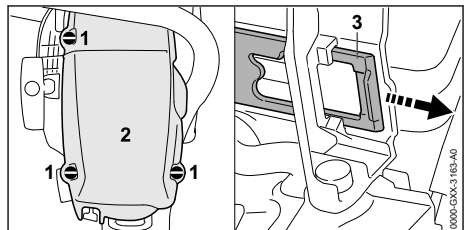

- ▶ Rotate the shroud fasteners (1) a quarter turn counterclockwise.
- ▶ Remove the shroud (2).
- ▶ Pull out the shutter (3).

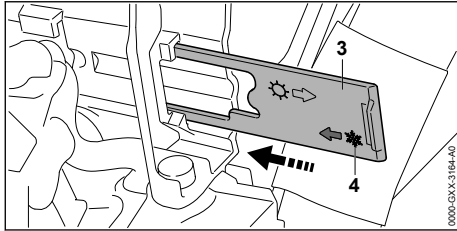

- ▶ Hold the shutter (3) with the symbol (4) pointing in the direction of the saw.
- ▶ Push the shutter (3) into the guide as far as stop.  
You will feel it engage.
- ▶ Place the shroud (2) in position.
- ▶ Rotate the shroud fasteners (1) clockwise until you hear a click.  
The shroud fasteners (1) are locked.

## 11.2 Summer Operation

The shutter must be set to summer mode when working at temperatures above +10°C.

- ▶ Shut off the engine and engage the chain brake.

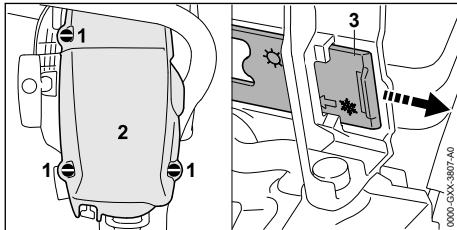

- ▶ Rotate the shroud fasteners (1) a quarter turn counterclockwise.
- ▶ Remove the shroud (2).
- ▶ Pull out the shutter (3).

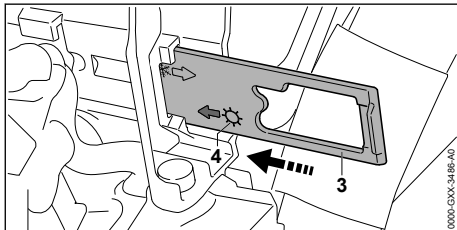

- ▶ Hold the shutter (3) with the symbol (4) pointing in the direction of the saw.
- ▶ Push the shutter (3) into the guide as far as stop.  
You will feel it engage.
- ▶ Place the shroud (2) in position.

- ▶ Rotate the shroud fasteners (1) clockwise until you hear a click.  
The shroud fasteners (1) are locked.

## 11.3 Calibrating the Saw

The chainsaw adjusts itself automatically for optimum performance during operation. Calibration enables the saw to be adjusted faster for optimum performance.

- ▶ If the outside temperature is below -10°C or the engine is cold:
  - ▶ Start the engine and disengage the chain brake.
  - ▶ Warm up the engine by opening and closing the throttle for about 1 minute.
  - ▶ Shut off the engine.

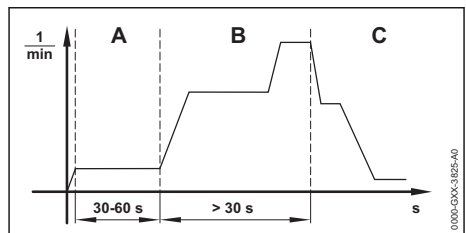

- ▶ Move the Master Control lever to position ▲.
- ▶ Engage the chain brake.
- ▶ Start the engine without depressing the throttle trigger.  
The engine runs and the Master Control lever remains in position ▲.
- ▶ Run the engine for at least 30 seconds but no more than 60 seconds (A) without depressing the throttle trigger.

### ⚠ WARNING

- If the chain brake is disengaged, the chain may rotate. This can result in serious injuries.
    - ▶ Hold the chainsaw as described in this instruction manual.
    - ▶ Do not touch the rotating saw chain.
- 
- ▶ Disengage the chain brake.

**NOTICE**

- The calibration process is aborted if the throttle trigger is released before the saw is properly calibrated. It is then necessary to restart the calibration process.
  - ▶ Keep the throttle trigger fully depressed.

**NOTICE**

- The chainsaw can be incorrectly calibrated if the throttle trigger is not kept fully depressed during calibration. This can damage the saw.
  - ▶ Keep the throttle trigger fully depressed.
- ▶ Depress the throttle trigger for at least 30 seconds (B) and hold it in that position. The engine accelerates and the chain rotates. Calibration of the saw takes place. Engine speed varies noticeably during calibration.
- ▶ If the engine stalls: Make another attempt to calibrate the saw.
- ▶ If the engine keeps stalling:
  - ▶ Engage the chain brake.
  - ▶ Do not use your chainsaw and contact your STIHL servicing dealer for assistance. Your saw has a malfunction.
- ▶ As soon as the engine speed drops noticeably (C): Release the throttle trigger. The engine runs at idling speed. Your saw is calibrated and ready for operation.

## 11.4 Adjusting Oil Feed Rate

The chainsaw has an adjustable oil pump.

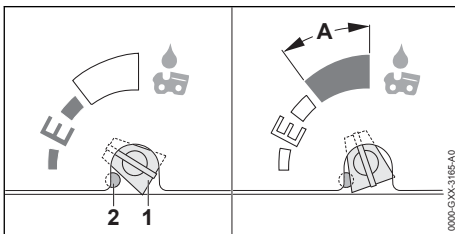

The oil feed rate is suitable for most applications when the oil pump adjusting screw (1) is in position E (Ematic).

The oil pump feed rate can be adjusted to suit different bar lengths, wood species and working techniques. The range of adjustment of the oil pump adjusting screw (1) is limited by a stop (2). The stop (2) can be depressed in order to further increase the oil feed rate.

### To increase oil feed rate

- ▶ Shut off the engine and engage the chain brake.
- ▶ Turn the oil pump adjusting screw (1) clockwise.

### To increase oil feed rate still further

- ▶ Shut off the engine and engage the chain brake.
- ▶ Use a suitable tool to depress the stop (2). The stop (2) remains permanently depressed.

**NOTICE**

- The oil tank will be drained at a faster rate if the oil pump adjusting screw (1) is in the 'A' segment. The point where the saw chain is no longer being lubricated properly will be reached sooner.
  - ▶ Fill the oil tank to maximum.
  - ▶ Move the oil pump adjusting screw away from the 'A' segment when the increased oil flow rate is no longer required.
- ▶ Turn the oil pump adjusting screw (1) clockwise.

### To reduce oil feed rate

- ▶ Shut off the engine and engage the chain brake.
- ▶ Turn the oil pump adjusting screw (1) counter-clockwise.

## 11.5 Holding and Controlling the Chainsaw

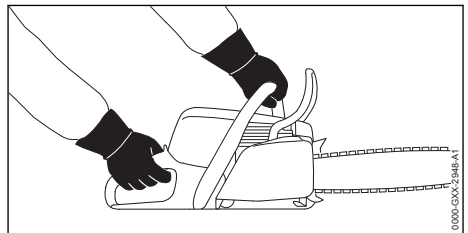

- ▶ Hold and control your chainsaw with your left hand on the handlebar and your right hand on the control handle. Wrap thumb of left hand around the handlebar and thumb of right hand around the control handle.

## 11.6 Sawing

### ! WARNING

- If kickback occurs, the chainsaw can be thrown up in the direction of the operator. This may result in serious or fatal injury to the user.
    - ▶ Always cut with the chain running at full speed.
    - ▶ Do not cut with the upper quadrant of the guide bar nose.
- 
- ▶ Begin the cut with the chain running at full speed and keep the guide bar vertical.

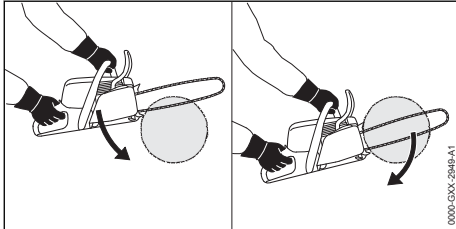

- ▶ Engage the spiked bumper and use it as a fulcrum.
- ▶ Guide the full width of the guide bar into the wood and reposition the spiked bumper as required.
- ▶ Take the weight of the chainsaw at the end of the cut.

## 11.7 Limbing

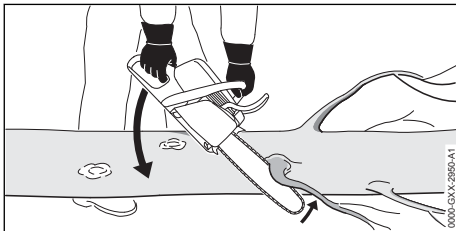

- ▶ Support the chainsaw on the log.
- ▶ With the chain running a full speed, pivot the guide bar downward against the limb.
- ▶ Cut through the limb with the top of the guide bar.

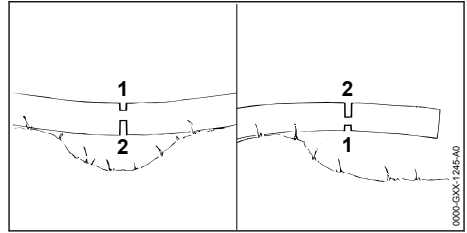

- ▶ If the limb is under tension: Make the relieving cut (1) at the compression side and then perform the bucking cut (2) from the tension side.

## 11.8 Felling

### 11.8.1 Determining direction of fall and escape path

- ▶ Determine direction of fall so that the area in which the tree falls is clear.

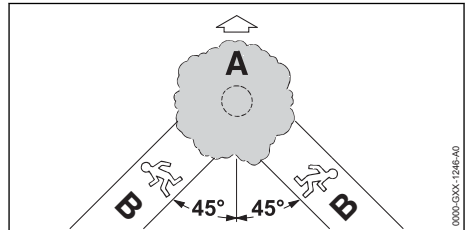

- ▶ Observe the following points when planning escape path (B):
  - Escape path (B) at an angle of 45° to direction of fall (A).
  - No obstacles on the escape path (B).
  - The top of the tree can be observed.
  - If the escape path (B) is on a slope, it must be parallel to the slope.

### 11.8.2 Preparing work area at base of tree

- ▶ Remove obstacles from work area at tree base.
- ▶ Remove growth from tree base.

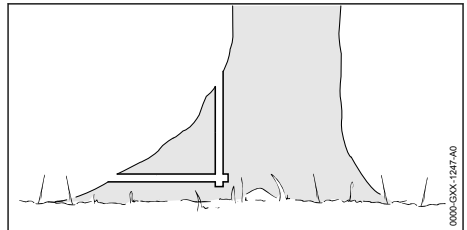

- ▶ If the tree has large, healthy buttress roots: Make vertical cut first and then a horizontal cut, and remove the resulting piece.

### 11.8.3 Basic information on felling cut

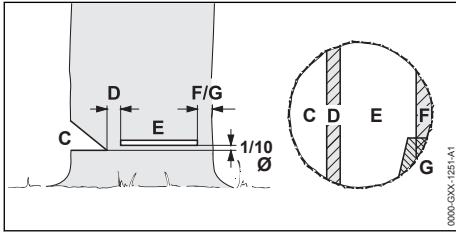

#### C Felling notch

The felling notch determines the direction of fall.

#### D Hinge

The hinge helps control the falling tree. The width of the hinge is 1/10 of the trunk diameter.

#### E Felling cut

The tree is felled with the felling cut. The felling cut is 1/10 of the trunk diameter (at least 3 cm) above the bottom of the felling notch.

#### F Stabilizing strap

The stabilizing strap supports the tree and helps prevent it from falling prematurely. The width of the stabilizing strap is 1/10 to 1/5 of the trunk diameter.

#### G Holding strap

The holding strap supports the tree and helps prevent it from falling prematurely. The width of the holding strap is 1/10 to 1/5 of the trunk diameter.

### 11.8.4 Cutting the felling notch

The felling notch determines the direction in which the tree falls. Country-specific standards for making the felling notch must be observed.

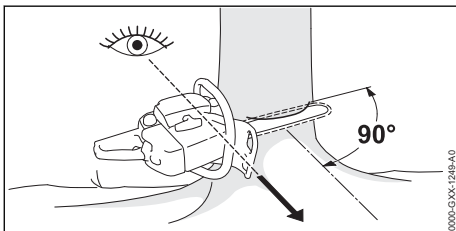

- ▶ Position the saw so that the felling notch is an right angles to the direction of fall and the saw is close to the ground.
- ▶ Make the horizontal cut.
- ▶ Make the angle cut at 45° to the horizontal cut.

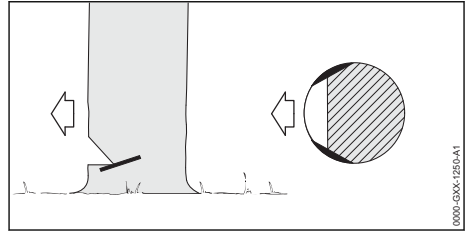

- ▶ If the wood is sound and long-fibered:
    - Observe the following points when making sapwood cuts:
      - The cuts must be the same at both sides.
      - The cuts must be at same height as bottom of felling notch.
      - The width of the cuts is 1/10 of the trunk diameter.
- The trunk does not splinter when the tree falls.

### 11.8.5 Plunge cutting

Plunge cutting is a technique required for felling.

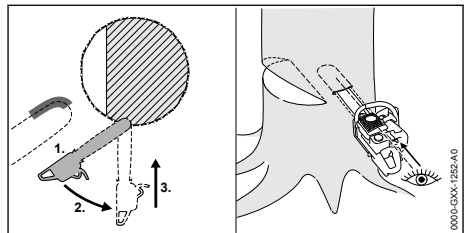

- ▶ Begin cut with the lower portion of the guide bar nose – with chain running at full speed.
- ▶ Cut until depth of kerf is twice the width of the guide bar.
- ▶ Swing the saw into plunge-cutting position.
- ▶ Perform the plunge cut

### 11.8.6 Selecting the Appropriate Felling Cut

The choice of appropriate felling cut depends on the following conditions:

- The natural inclination of the tree
- The tree's branch formation
- Damage to the tree
- The tree's state of health
- If there is snow on the tree: the snow load
- The direction of slope
- Wind direction and speed
- Nearby trees, if any

There are different features of these conditions. Only two features are described in this Instruction Manual.

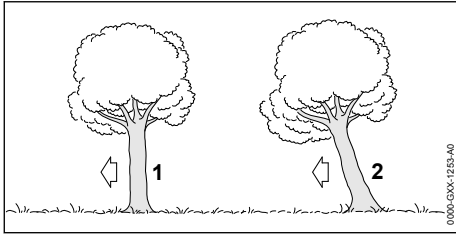

### 1 Normal tree

A normal tree is vertical and has an even crown.

### 2 Leaner

A leaner stands at an angle and the crown faces in the direction of fall.

### 11.8.7 Felling normal, small diameter tree

A normal tree is felled with a felling cut and stabilizing strap. This felling cut must be performed if the tree diameter is less than the guide bar's length.

- ▶ Shout a warning.

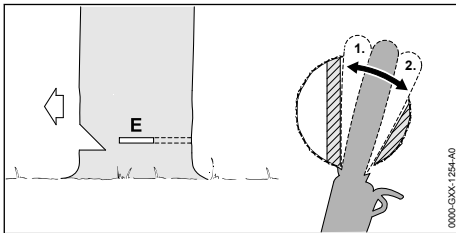

- ▶ Plunge the guide bar into the felling cut until it is visible at the other side of the trunk, 

#### 11.8.5.

- ▶ Apply the spiked bumper behind the hinge and use it as a pivot.
- ▶ Enlarge felling cut in direction of hinge.
- ▶ Enlarge felling cut in direction of stabilizing strap.

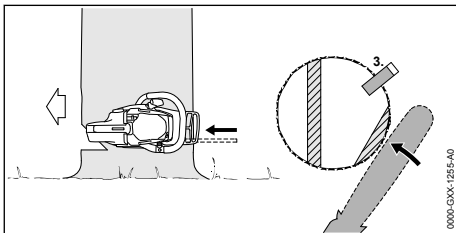

- ▶ Insert a felling wedge. The felling wedge must match the tree diameter and the width of the felling cut.
- ▶ Shout a warning.

- ▶ With outstretched arms, cut through the stabilizing strap horizontally from outside at the same level as the felling cut.  
The tree falls.

### 11.8.8 Felling normal, large diameter tree

A normal tree is felled with a felling cut and stabilizing strap. This felling cut must be performed if the tree diameter is greater than the guide bar's length.

- ▶ Shout a warning.

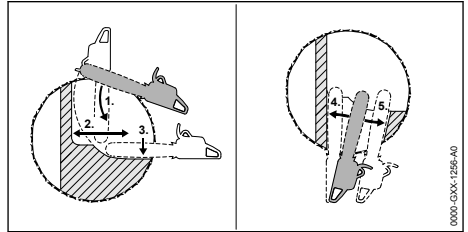

- ▶ Apply the spiked bumper at the same height as the felling cut and use it as a pivot.
- ▶ Hold the saw horizontally and swing it into the felling cut as far as possible.
- ▶ Enlarge felling cut in direction of hinge.
- ▶ Enlarge felling cut in direction of stabilizing strap.
- ▶ Move to the other side of the tree.
- ▶ Plunge the guide bar into the felling cut at the same height.
- ▶ Enlarge felling cut in direction of hinge.
- ▶ Enlarge felling cut in direction of stabilizing strap.

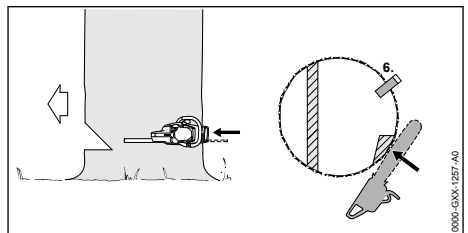



- ▶ Insert a felling wedge. The felling wedge must match the tree diameter and the width of the felling cut.
- ▶ Shout a warning.
- ▶ With outstretched arms, cut through the stabilizing strap horizontally from outside at the same level as the felling cut.  
The tree falls.

### 11.8.9 Felling a small diameter leaner

A leaner is felled with a felling cut and holding strap. This felling cut must be performed if the tree diameter is less than the guide bar's length.

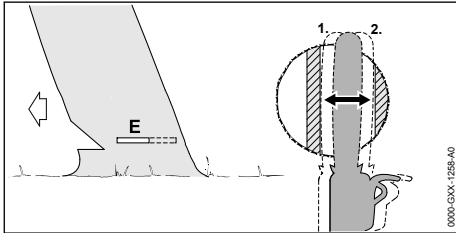
- ▶ Shout a warning.



- ▶ Plunge the guide bar into the felling cut until it is visible at the other side of the trunk,  11.8.5.
- ▶ Enlarge felling cut in direction of hinge.
- ▶ Enlarge felling cut in direction of holding strap.

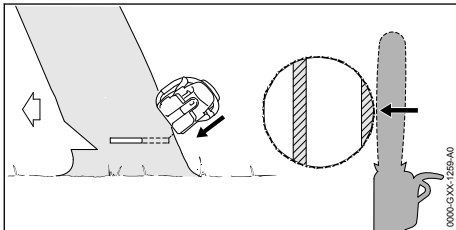

- ▶ Shout a warning.
- ▶ With arms outstretched, cut through the holding strap from outside at a downward angle. The tree falls.

### 11.8.10 Felling a large diameter leaner

A leaner is felled with a felling cut and holding strap. This felling cut must be performed if the tree diameter is greater than the guide bar's length.

- ▶ Shout a warning.

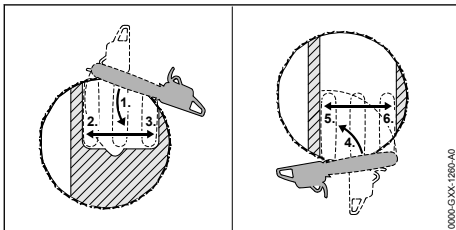

- ▶ Apply the spiked bumper behind the holding strap at the same height as the felling cut and use it as a pivot.
- ▶ Hold the saw horizontally and swing it into the felling cut as far as possible.

- ▶ Enlarge felling cut in direction of hinge.
- ▶ Enlarge felling cut in direction of holding strap.
- ▶ Move to the other side of the tree.
- ▶ Apply the spiked bumper behind the hinge at the same height as the felling cut and use it as a pivot.
- ▶ Hold the saw horizontally and swing it into the felling cut as far as possible.
- ▶ Enlarge felling cut in direction of hinge.
- ▶ Enlarge felling cut in direction of holding strap.

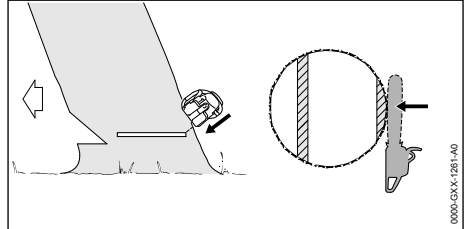

- ▶ Shout a warning.
- ▶ With arms outstretched, cut through the holding strap from outside at a downward angle. The tree falls.

## 12 After Finishing Work

### 12.1 After Finishing Work

- ▶ Shut off the engine and engage the chain brake.
- ▶ Allow chainsaw to cool down.
- ▶ If the saw is wet: Allow the saw to dry.
- ▶ Clean the saw.
- ▶ Clean the bar and chain.
- ▶ Loosen nuts on the chain sprocket cover.
- ▶ Turn the tensioning screw two full turns counterclockwise. The chain is now slack.
- ▶ Tighten down nuts on the chain sprocket cover.
- ▶ Fit the scabbard so that it completely covers the guide bar.

## 13 Transporting

### 13.1 Transporting the Chainsaw

- ▶ Shut off the engine and engage the chain brake.
- ▶ Fit the chain scabbard so that it completely covers the guide bar.

#### Carrying the chainsaw

- ▶ Carry the chainsaw by holding the front handle in your right hand with the guide bar pointing to the rear.

### Carrying the chainsaw in a vehicle

- ▶ Secure the saw to prevent tipping over and movement.

## 14 Storing

### 14.1 Storing the Chainsaw

- ▶ Shut off the engine and engage the chain brake.
- ▶ Fit the chain scabbard so that it completely covers the guide bar.
- ▶ Observe the following points when storing the chainsaw:
  - Chainsaw is out of reach of children.
  - The chainsaw is clean and dry.
- ▶ If you store the chainsaw for more than 30 days:
  - ▶ Remove the guide bar and saw chain.
  - ▶ Open the fuel tank cap.
  - ▶ Drain the fuel tank.
  - ▶ Close the fuel tank.
  - ▶ If a manual fuel pump is fitted: Press the manual fuel pump at least 5 times.
  - ▶ Start the engine and run it at idling speed until it stops.

## 15 Cleaning

### 15.1 Cleaning the Saw

- ▶ Shut off the engine and engage the chain brake.
- ▶ Allow chainsaw to cool down
- ▶ Clean the saw with a damp cloth or STIHL resin solvent.
- ▶ Clean cooling air slots with a soft brush.

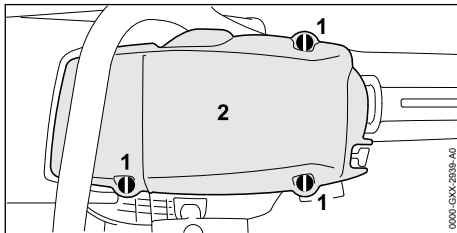

- ▶ Rotate the shroud fasteners (1) a quarter turn counterclockwise.
- ▶ Remove the shroud (2).
- ▶ Remove the chain sprocket cover.
- ▶ Use a soft brush, damp cloth or STIHL resin solvent to clean the cylinder fins and the inside of the shroud.
- ▶ Clean the area around the sprocket with a damp cloth or STIHL resin solvent.
- ▶ Place the shroud (2) in position.

- ▶ Rotate the shroud fasteners (1) clockwise until you hear a click.  
The shroud fasteners are locked.
- ▶ Fit the chain sprocket cover.

### 15.2 Cleaning the Bar and Chain

- ▶ Shut off the engine and engage the chain brake.
- ▶ Remove the bar and chain.

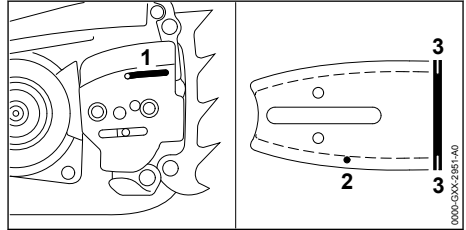

- ▶ Clean the oil port (1), oil inlet hole (2) and bar groove (3) with a soft brush or STIHL resin solvent.
- ▶ Clean the saw chain with a soft brush or STIHL resin solvent.
- ▶ Mount the bar and chain.

### 15.3 Cleaning the Air Filter

Very fine dust can collect in the air filter. The dust can clog the filter and cannot be removed by brushing or knocking out. The air filter must be cleaned with a cleaning agent.

- ▶ Shut off the engine and engage the chain brake.

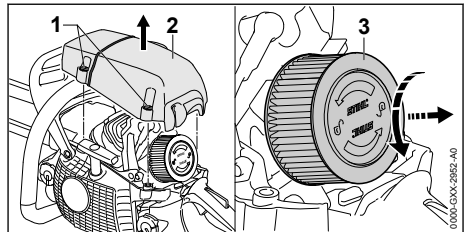

- ▶ Rotate the shroud fasteners (1) a quarter turn counterclockwise.
- ▶ Remove the shroud (2).
- ▶ Clean the area around the air filter (3) with a damp cloth or a soft brush.
- ▶ Rotate the air filter (3) a quarter turn counterclockwise by hand.
- ▶ Remove the air filter (3).
- ▶ Rinse away coarse dirt from the outside of the filter (3) under running water.
- ▶ If the air filter (3) is damaged. Install a new air filter (3).



## ! WARNING

- Cleaning agent may cause irritation if it contacts the skin or eyes.
    - ▶ Observe the information supplied with the cleaning agent.
    - ▶ Avoid contact with cleaning agents.
    - ▶ In case of contact with the skin: Wash affected areas with plenty of water and soap.
    - ▶ In case of contact with the eyes: Rinse eyes with plenty of water for at least 15 minutes and seek medical advice.
- 
- ▶ Spray the outside and inside of the air filter (3) with STIHL special cleaner or a cleaning agent with a pH value higher than 12.
  - ▶ Allow STIHL special cleaner or cleaning agent to act for 10 minutes.
  - ▶ Use a soft brush to clean the outside of the air filter (3).
  - ▶ Rinse the outside and inside of the air filter (3) under running water.
  - ▶ Allow air filter (3) to dry in the air.

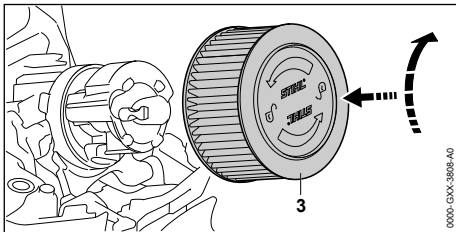

- ▶ Push the air filter (3) into place by hand and rotate it clockwise until it engages in position. The "STIHL" logo is horizontal.
- ▶ Place the shroud (2) in position.
- ▶ Rotate the shroud fasteners (1) clockwise until you hear a click. The shroud fasteners (1) are locked.

### 15.4 Cleaning the spark plug

- ▶ Shut off the engine and engage the chain brake.
- ▶ Allow the chainsaw to cool down.

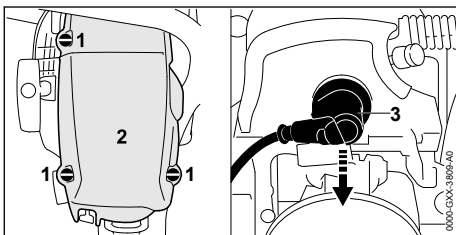

- ▶ Turn the shroud locks (1) a quarter-turn counterclockwise.
- ▶ Remove shroud (2).
- ▶ Pull off the spark plug boot (3).
- ▶ If the area around the spark plug is soiled: Clean it with a cloth.
- ▶ Unscrew the spark plug.
- ▶ Clean the spark plug with a cloth.
- ▶ If the spark plug is corroded: Replace the spark plug.

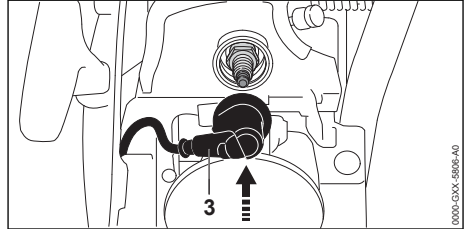

- ▶ Insert and tighten down the spark plug.
- ▶ Press the spark plug boot (3) firmly home.
- ▶ Fit the shroud (2).
- ▶ Turn the shroud locks (1) a quarter-turn clockwise. The shroud locks are locked.

## 16 Maintenance

### 16.1 Maintenance Intervals

The maintenance intervals are dependent on the environmental and operating conditions. STIHL recommends the following maintenance intervals:

#### Chain brake

- ▶ Have the chain brake serviced by a STIHL servicing dealer at the following intervals:
  - Full-time usage: every 3 months
  - Part-time usage: every 6 months
  - Occasional usage: every 12 months

#### After every 100 hours of operation

- ▶ Install a new spark plug.

#### Weekly

- ▶ Check the chain sprocket.
- ▶ Check and deburr the guide bar.
- ▶ Check and sharpen the saw chain.

#### Monthly

- ▶ Clean the air filter.
- ▶ Have oil tank cleaned by a STIHL servicing dealer.
- ▶ Have fuel tank cleaned by a STIHL servicing dealer.

- ▶ Have pickup body (filter) in fuel tank cleaned by a STIHL servicing dealer.

### Every 12 months

- ▶ Have pickup body (filter) in fuel tank replaced by a STIHL servicing dealer.

## 16.2 Deburring the Guide Bar

A burr can build up on the outer edge of the guide bar.

- ▶ Remove burr with a flat file or a STIHL guide bar dressing tool.
- ▶ If you have any queries: Contact your STIHL servicing dealer.

## 16.3 Sharpening the Saw Chain

Correctly sharpening saw chains requires a lot of practice.

STIHL files, STIHL filing aids, STIHL sharpeners and the brochure "Sharpening STIHL Saw Chains" help you achieve the right results. To obtain the brochure visit <http://www.stihl.com/sharpening-brochure>.

STIHL recommends you have saw chains resharpened by a STIHL servicing dealer.

### ! WARNING

- The chain's cutters are very sharp. There is a risk of cut injuries.
  - ▶ Wear work gloves made of durable material.

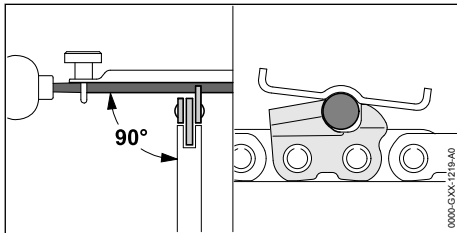

## 18 Troubleshooting

### 18.1 Troubleshooting Chainsaw

Most malfunctions have the same causes.

- ▶ Perform the following operations:
  - ▶ Clean the air filter.
  - ▶ Clean or replace the spark plug.
  - ▶ Adjust saw for winter or summer operation.
- ▶ If the malfunction still exists: Take the action described in the following table.

Condition	Cause	Remedy
Engine does not start.	Insufficient fuel in the tank.	▶ Mix fuel and refuel the chainsaw.

- ▶ File each cutter with a round file so that the following points are observed:
  - Round file matches the chain pitch.
  - File from the inside to the outside of the cutter.
  - Hold the file at right angle to the guide bar.
  - Maintain a filing angle of 30°.

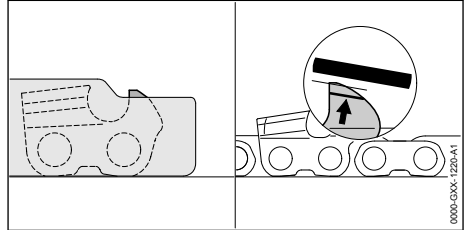

- ▶ File down the depth gauges with a flat file so that they are level with the STIHL filing gauge and parallel to the service mark. The STIHL filing gauge must match the chain pitch.
- ▶ If you have any queries: Contact your STIHL servicing dealer for assistance.

## 17 Repairing

### 17.1 Repairing the Chain Saw, Guide Bar and Saw Chain

The chain saw, guide bar and saw chain cannot be repaired by the user.

- ▶ If the saw, guide bar or saw chain is damaged: Do not use your saw, guide bar or saw chain, and contact your STIHL servicing dealer.

Condition	Cause	Remedy
	Engine is flooded.	▶ Clear the combustion chamber.
	Carburetor is too hot.	▶ Allow chainsaw to cool down.
	Carburetor is iced up.	▶ Allow saw to warm up to +10°C.
Engine idles erratically.	Carburetor is iced up.	▶ Allow saw to warm up to +10°C.
Engine stops while idling	Carburetor is iced up.	▶ Allow saw to warm up to +10°C.
Poor acceleration	The chain is over-tensioned.	▶ Tension chain properly.
	Chain lubrication system is supplying insufficient chain oil.	▶ Increase oil feed rate.
Engine does not reach maximum RPM.	Saw is not correctly tuned to ambient conditions.	▶ Calibrate the saw.
Saw chain does not rotate when throttle is opened.	The chain brake is engaged.	▶ Disengage the chain brake.
	The chain is over-tensioned.	▶ Tension chain properly.
	Bar nose sprocket is blocked.	▶ Clean the bar nose sprocket with STIHL resin solvent.
Smoke or burning smell while cutting.	Chain is not properly sharpened.	▶ Sharpen the chain properly.
	Insufficient chain oil in the tank.	▶ Fill up with chain oil.
	Chain lubrication system is supplying insufficient chain oil.	▶ Increase oil feed rate.
	The chain is over-tensioned.	▶ Tension chain properly.
	Chainsaw is not being used properly.	▶ Have correct use explained, then practice.

## 18.2 Clearing the Combustion Chamber

- ▶ Engage the chain brake.

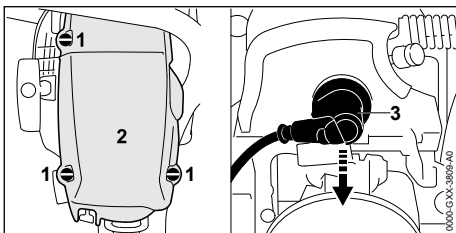

- ▶ Rotate the shroud fasteners (1) a quarter turn counterclockwise.
- ▶ Remove the shroud (2).
- ▶ Pull off the spark plug boot (3).
- ▶ Unscrew the spark plug.
- ▶ Dry the spark plug.

### WARNING

- Unconfined sparks may occur if the starter grip is pulled after the spark plug boot has been removed. Sparks may cause a fire or an explosion in an easily combustible or explosive environment. This can result in serious or fatal injuries and damage to property.
  - ▶ Move the Master Control lever to position  and hold it there before pulling the starter grip.
- ▶ Move the Master Control lever to position and hold it there.
- ▶ Pull the starter grip (3) and guide it back several times. The combustion chamber is cleared.
- ▶ Insert and tighten down the spark plug.

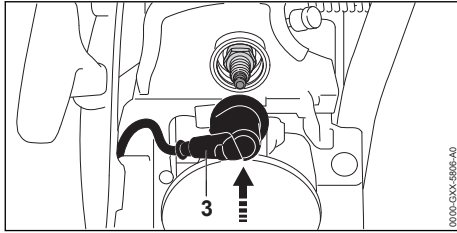

- ▶ Connect the spark plug boot (3) and press it down firmly.
- ▶ Place the shroud (2) in position.
- ▶ Rotate the shroud fasteners (1) clockwise until you hear a click.  
The shroud fasteners are locked.

## 19 Specifications

### 19.1 STIHL MS 462 C-M Chainsaw

- Displacement: 72.2 cc
- Engine power to ISO 7293: 4.4 kW (6 bhp)
- Idle speed to ISO 11681: 2,800 ± 50 rpm
- Approved spark plug: NGK CMR6H from STIHL
- Electrode gap: 0.5 mm
- Dry weight without guide bar and chain
  - MS 462 C-M: 6.0 kg
  - MS 462 C-M with handle and carburetor heating: 6.1 kg
- Max. fuel tank capacity: 720 cc (0.72 l)
- Max. oil tank capacity: 340 cc (0.34 l)

### 19.2 Chain Sprockets and Chain Speeds

The following chain sprockets may be used:  
7-tooth for 3/8"

- Maximum chain speed according to ISO 11681: 28.9 m/s
- Chain speed at maximum power: 21.7 m/s

### 19.3 Minimum Groove Depth of Guide Bars

The minimum groove depth depends on the pitch of the guide bar.

## 20 Bar and Chain Combinations

### 20.1 STIHL MS 462 Chainsaw

Pitch	Drive link gauge/groove width	Length	Guide bar	Nose sprocket teeth	Number of drive links	Saw chain
3/8"	1.6 mm	40 cm	Rollomatic E	11	60	36 RS (Type 3621)
			Rollomatic ES			

- 3/8": 6 mm

### 19.4 Noise and Vibration Data

- Sound pressure level  $L_p$  measured according to ISO 22868: 108 dB(A) K-value for noise pressure level is 2 dB(A).
- Sound power level  $L_w$  measured according to ISO 22868: 119 dB(A) K-value for sound power level is 2 dB(A).
- Vibration level  $a_{hv}$  measured according to ISO 22867:
  - Front handle (handlebar): 4.8 m/s<sup>2</sup> K-value for vibration level is 2 m/s<sup>2</sup>.
  - Rear handle: 3.6 m/s<sup>2</sup> K-value for vibration level is 2 m/s<sup>2</sup>.

For further details on compliance with Vibration Directive 2002/44/EC visit [www.stihl.com/vib](http://www.stihl.com/vib)

### 19.5 REACH

REACH is an EC regulation and stands for the Registration, Evaluation, Authorisation and Restriction of Chemical substances.

For information on compliance with the REACH regulation see [www.stihl.com/reach](http://www.stihl.com/reach).

### 19.6 Exhaust Emissions

The CO<sub>2</sub> value measured in the EU type approval procedure is specified at [www.stihl.com/co2](http://www.stihl.com/co2) in the product-specific technical data.

The measured CO<sub>2</sub> value was determined on a representative engine in accordance with a standardised test procedure under laboratory conditions and does not represent either an explicit or implied guarantee of the performance of a specific engine.

The applicable exhaust emission requirements are fulfilled by the intended usage and maintenance described in this instruction manual. The type approval expires if the engine is modified in any way.

Pitch	Drive link gauge/groove width	Length	Guide bar	Nose sprocket teeth	Number of drive links	Saw chain
		45 cm	Rollomatic E	11	66	36 RS3 (Type 3626) 36 RM (Type 3652)
			Rollomatic ES			
		50 cm	Rollomatic E	11	72	
			Rollomatic ES			
			Rollomatic ES Light			
			Duromatic E			
		55 cm	Rollomatic ES	11	76	
		63 cm	Rollomatic E	11	84	
			Rollomatic ES			
			Rollomatic ES Light			
		71 cm	Rollomatic ES	11	91	
			Rollomatic ES Light			
		75 cm	Rollomatic ES	11	98	

The cutting length of a guide bar depends on the chainsaw and the saw chain being used. Actual cutting length may be less than the specified length

## 21 Spare Parts and Accessories

### 21.1 Spare parts and accessories

**STIHL**  These symbols indicate original STIHL spare parts and original STIHL accessories.

STIHL recommends the use of original STIHL spare parts and accessories.

Despite ongoing market observation, STIHL is unable to judge the reliability, safety and suitability of other manufacturers' spare parts and accessories; accordingly, STIHL cannot warrant for the use of those parts.

Original STIHL spare parts and original STIHL accessories are available from STIHL dealers.

## 22 Disposal

### 22.1 Disposing of Chainsaw

Contact the local authorities or your STIHL dealer for information on disposal.

Improper disposal can be harmful to health and pollute the environment.

- ▶ Take STIHL products including packaging to a suitable collection point for recycling in accordance with local regulations.
- ▶ Do not dispose with domestic waste.

## 23 EC Declaration of Conformity

### 23.1 STIHL MS 462 C-M Chainsaw

ANDREAS STIHL AG & Co. KG  
Badstraße 115  
D-71336 Waiblingen  
Germany

declares under our sole responsibility that

- Category: chainsaw
- Manufacturer's brand: STIHL
- Type: MS 462 C-M, MS 462 C-M VV
- Serial number: 1142
- Displacement: 72.2 cm<sup>3</sup>

conforms to the relevant provisions of Directives 2011/65/EU, 2006/42/EC, 2014/30/EU and 2000/14/EC and has been developed and manufactured in compliance with the following standards in the versions valid on the date of production: EN ISO 11681-1, EN 55012 and EN 61000-6-1.

The EC type examination pursuant to Directive 2006/42/EC Art. 12.3(b) was carried out by DPLF, Deutsche Prüf- und Zertifizierungsstelle für Land- und Forsttechnik GbR (NB 0363), Spremberger Straße 1, 64823 Groß-Umstadt, Germany

- Certification number K-EG -2016/7987

The measured and guaranteed sound power levels were determined according to Directive 2000/14/EC, Annex V, using the ISO 9207 standard.

- Measured sound power level: 119 dB(A)
- Guaranteed sound power level: 121 dB(A)

The technical documents are stored at ANDREAS STIHL AG & Co. KG Produktzulassung.

The year of manufacture and serial number are applied to the chainsaw.

Done at Waiblingen, 03.02.2020

ANDREAS STIHL AG & Co. KG



Dr. Jürgen Hoffmann, Director Product Certification & Regulatory Affairs

## 24 UKCA Declaration of Conformity

### 24.1 STIHL MS 462 C-M Chainsaw

**UK  
CA**

ANDREAS STIHL AG & Co. KG  
Badstraße 115  
D-71336 Waiblingen  
Germany

declares under our sole responsibility that

- Category: chainsaw
- Manufacturer's brand: STIHL
- Model: MS 462 C-M
- Serial number: 1142
- Displacement: 72.2 cm<sup>3</sup>

conforms to the relevant provisions of UK regulations The Restriction of the Use of Certain Hazardous Substances in Electrical and Electronic Equipment Regulations 2012, Supply of Machinery (Safety) Regulations 2008, Electromagnetic Compatibility Regulations 2016 and Noise Emission in the Environment by Equipment for use Outdoors Regulations 2001 and has been manufactured in compliance with the following standards in the versions valid on the date of production: EN ISO 11681-1, EN 55012 and EN 61000-6-1.

The type examination was carried out by: Inter-tek Testing & Certification Ltd, Academy Place, 1-9 Brook Street, Brentwood, Essex, CM14 5NQ, United Kingdom

– Certification number: ITS UK MCR 17  
The measured and guaranteed sound power levels have been determined in accordance with the UK regulation Noise Emission in the Environment by Equipment for use Outdoors Regulations 2001 Schedule 8, using the ISO 9207 standard.

- Measured sound power level: 119 dB(A)
- Guaranteed sound power level: 121 dB(A)

The technical documents are stored at ANDREAS STIHL AG & Co. KG.

The year of manufacture and serial number are indicated on the chainsaw.

Waiblingen, 31.03.2022

ANDREAS STIHL AG & Co. KG



Dr. Jürgen Hoffmann, Director Product Certification & Regulatory Affairs



[www.stihl.com](http://www.stihl.com)



0458-790-0121-C



0458-790-0121-C